



RX-V757

AV Receiver

OWNER'S MANUAL

IMPORTANT SAFETY INSTRUCTIONS

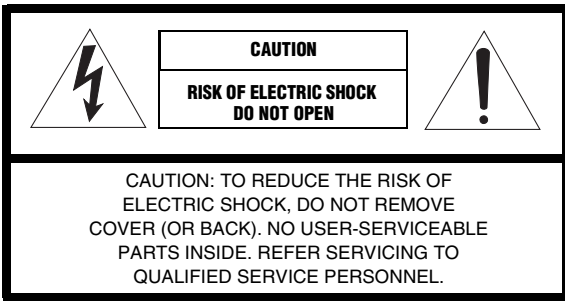

• Explanation of Graphical Symbols

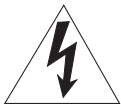

The lightning flash with arrowhead symbol, within an equilateral triangle, is intended to alert you to the presence of uninsulated “dangerous voltage” within the product’s enclosure that may be of sufficient magnitude to constitute a risk of electric shock to persons.



The exclamation point within an equilateral triangle is intended to alert you to the presence of important operating and maintenance (servicing) instructions in the literature accompanying the appliance.

- 1** Read Instructions – All the safety and operating instructions should be read before the product is operated.
- 2** Retain Instructions – The safety and operating instructions should be retained for future reference.
- 3** Heed Warnings – All warnings on the product and in the operating instructions should be adhered to.
- 4** Follow Instructions – All operating and use instructions should be followed.
- 5** Cleaning – Unplug this product from the wall outlet before cleaning. Do not use liquid cleaners or aerosol cleaners. Use a damp cloth for cleaning.
- 6** Attachments – Do not use attachments not recommended by the product manufacturer as they may cause hazards.
- 7** Water and Moisture – Do not use this product near water – for example, near a bath tub, wash bowl, kitchen sink, or laundry tub; in a wet basement; or near a swimming pool; and the like.
- 8** Accessories – Do not place this product on an unstable cart, stand, tripod, bracket, or table. The product may fall, causing serious injury to a child or adult, and serious damage to the product. Use only with a cart, stand, tripod, bracket, or table recommended by the manufacturer, or sold with the product. Any mounting of the product should follow the manufacturer’s instructions, and should use a mounting accessory recommended by the manufacturer.
- 9** A product and cart combination should be moved with care. Quick stops, excessive force, and uneven surfaces may cause the product and cart combination to overturn.
- 10** Ventilation – Slots and openings in the cabinet are provided for ventilation and to ensure reliable operation of the product and to protect it from overheating, and these openings must not be blocked or covered. The openings should never be blocked by placing the product on a bed, sofa, rug, or other similar surface. This product should not be placed in a built-in installation such as a bookcase or rack unless proper ventilation is provided or the manufacturer’s instructions have been adhered to.
- 11** Power Sources – This product should be operated only from the type of power source indicated on the marking label. If you are not sure of the type of power supply to your home, consult your product dealer or local power company. For products intended to operate from battery power, or other sources, refer to the operating instructions.
- 12** Grounding or Polarization – This product may be equipped with a polarized alternating current line plug (a plug having one blade wider than the other). This plug will fit into the power outlet only one way. This is a safety feature. If you are unable to insert the plug fully into the outlet, try reversing the plug. If the plug should still fail to fit, contact your electrician to replace your obsolete outlet. Do not defeat the safety purpose of the polarized plug.
- 13** Power-Cord Protection – Power-supply cords should be routed so that they are not likely to be walked on or pinched by items placed upon or against them, paying particular attention to cords at plugs, convenience receptacles, and the point where they exit from the product.
- 14** Lightning – For added protection for this product during a lightning storm, or when it is left unattended and unused for long periods of time, unplug it from the wall outlet and disconnect the antenna or cable system. This will prevent damage to the product due to lightning and power-line surges.
- 15** Power Lines – An outside antenna system should not be located in the vicinity of overhead power lines or other electric light or power circuits, or where it can fall into such power lines or circuits. When installing an outside antenna system, extreme care should be taken to keep from touching such power lines or circuits as contact with them might be fatal.
- 16** Overloading – Do not overload wall outlets, extension cords, or integral convenience receptacles as this can result in a risk of fire or electric shock.
- 17** Object and Liquid Entry – Never push objects of any kind into this product through openings as they may touch dangerous voltage points or short-out parts that could result in a fire or electric shock. Never spill liquid of any kind on the product.
- 18** Servicing – Do not attempt to service this product yourself as opening or removing covers may expose you to dangerous voltage or other hazards. Refer all servicing to qualified service personnel.
- 19** Damage Requiring Service – Unplug this product from the wall outlet and refer servicing to qualified service personnel under the following conditions:
 - a)** When the power-supply cord or plug is damaged,
 - b)** If liquid has been spilled, or objects have fallen into the product,
 - c)** If the product has been exposed to rain or water,



- d) If the product does not operate normally by following the operating instructions. Adjust only those controls that are covered by the operating instructions as an improper adjustment of other controls may result in damage and will often require extensive work by a qualified technician to restore the product to its normal operation,
 - e) If the product has been dropped or damaged in any way, and
 - f) When the product exhibits a distinct change in performance - this indicates a need for service.
- 20 Replacement Parts** – When replacement parts are required, be sure the service technician has used replacement parts specified by the manufacturer or have the same characteristics as the original part. Unauthorized substitutions may result in fire, electric shock, or other hazards.
- 21 Safety Check** – Upon completion of any service or repairs to this product, ask the service technician to perform safety checks to determine that the product is in proper operating condition.
- 22 Wall or Ceiling Mounting** – The unit should be mounted to a wall or ceiling only as recommended by the manufacturer.
- 23 Heat** – The product should be situated away from heat sources such as radiators, heat registers, stoves, or other products (including amplifiers) that produce heat.

24 Outdoor Antenna Grounding – If an outside antenna or cable system is connected to the product, be sure the antenna or cable system is grounded so as to provide some protection against voltage surges and built-up static charges. Article 810 of the National Electrical Code, ANSI/NFPA 70, provides information with regard to proper grounding of the mast and supporting structure, grounding of the lead-in wire to an antenna discharge unit, size of grounding conductors, location of antenna discharge unit, connection to grounding electrodes, and requirements for the grounding electrode.

EXAMPLE OF ANTENNA GROUNDING

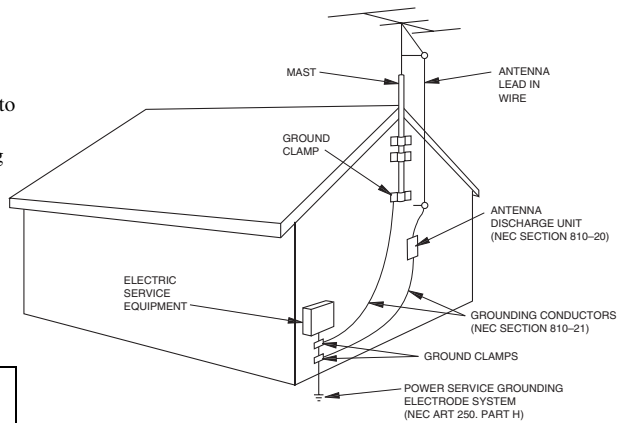

NEC – NATIONAL ELECTRICAL CODE

Note to CATV system installer:

This reminder is provided to call the CATV system installer’s attention to Article 820-40 of the NEC that provides guidelines for proper grounding and, in particular, specifies that the cable ground shall be connected to the grounding system of the building, as close to the point of cable entry as practical.

FCC INFORMATION (for US customers)

1 IMPORTANT NOTICE: DO NOT MODIFY THIS UNIT!

This product, when installed as indicated in the instructions contained in this manual, meets FCC requirements. Modifications not expressly approved by Yamaha may void your authority, granted by the FCC, to use the product.

2 IMPORTANT: When connecting this product to accessories and/or another product use only high quality shielded cables. Cable/s supplied with this product **MUST** be used. Follow all installation instructions. Failure to follow instructions could void your FCC authorization to use this product in the USA.

3 NOTE: This product has been tested and found to comply with the requirements listed in FCC Regulations, Part 15 for Class “B” digital devices. Compliance with these requirements provides a reasonable level of assurance that your use of this product in a residential environment will not result in harmful interference with other electronic devices.

This equipment generates/uses radio frequencies and, if not installed and used according to the instructions found in the users manual, may cause interference harmful to the operation of other electronic devices.

Compliance with FCC regulations does not guarantee that interference will not occur in all installations. If this product is found to be the source of interference, which can be determined by turning the unit “OFF” and “ON”, please try to eliminate the problem by using one of the following measures:

Relocate either this product or the device that is being affected by the interference.

Utilize power outlets that are on different branch (circuit breaker or fuse) circuits or install AC line filter/s.

In the case of radio or TV interference, relocate/reorient the antenna. If the antenna lead-in is 300 ohm ribbon lead, change the lead-in to coaxial type cable.

If these corrective measures do not produce satisfactory results, please contact the local retailer authorized to distribute this type of product. If you can not locate the appropriate retailer, please contact Yamaha Electronics Corp., U.S.A. 6660 Orangethorpe Ave, Buena Park, CA 90620.

The above statements apply **ONLY** to those products distributed by Yamaha Corporation of America or its subsidiaries.

CAUTION: READ THIS BEFORE OPERATING YOUR UNIT.

- 1 To assure the finest performance, please read this manual carefully. Keep it in a safe place for future reference.
- 2 Install this sound system in a well ventilated, cool, dry, clean place – away from direct sunlight, heat sources, vibration, dust, moisture, and/or cold. Allow ventilation space of at least 30 cm on the top, 20 cm on the left and right, and 20 cm on the back of this unit.
- 3 Locate this unit away from other electrical appliances, motors, or transformers to avoid humming sounds.
- 4 Do not expose this unit to sudden temperature changes from cold to hot, and do not locate this unit in a environment with high humidity (i.e. a room with a humidifier) to prevent condensation inside this unit, which may cause an electrical shock, fire, damage to this unit, and/or personal injury.
- 5 Avoid installing this unit where foreign object may fall onto this unit and/or this unit may be exposed to liquid dripping or splashing. On the top of this unit, do not place:
 - Other components, as they may cause damage and/or discoloration on the surface of this unit.
 - Burning objects (i.e. candles), as they may cause fire, damage to this unit, and/or personal injury.
 - Containers with liquid in them, as they may fall and liquid may cause electrical shock to the user and/or damage to this unit.
- 6 Do not cover this unit with a newspaper, tablecloth, curtain, etc. in order not to obstruct heat radiation. If the temperature inside this unit rises, it may cause fire, damage to this unit, and/or personal injury.
- 7 Do not plug in this unit to a wall outlet until all connections are complete.
- 8 Do not operate this unit upside-down. It may overheat, possibly causing damage.
- 9 Do not use force on switches, knobs and/or cords.
- 10 When disconnecting the power cord from the wall outlet, grasp the plug; do not pull the cord.
- 11 Do not clean this unit with chemical solvents; this might damage the finish. Use a clean, dry cloth.
- 12 Only voltage specified on this unit must be used. Using this unit with a higher voltage than specified is dangerous and may cause fire, damage to this unit, and/or personal injury. YAMAHA will not be held responsible for any damage resulting from use of this unit with a voltage other than specified.
- 13 To prevent damage by lightning, disconnect the power cord and outdoor antenna from the wall outlet during an electrical storm.
- 14 Do not attempt to modify or fix this unit. Contact qualified YAMAHA service personnel when any service is needed. The cabinet should never be opened for any reasons.
- 15 When not planning to use this unit for long periods of time (i.e. vacation), disconnect the AC power plug from the wall outlet.
- 16 Be sure to read the “TROUBLESHOOTING” section on common operating errors before concluding that this unit is faulty.
- 17 Before moving this unit, press **STANDBY/ON** to set this unit in the standby mode, and disconnect the AC power plug from the wall outlet.
- 18 **VOLTAGE SELECTOR (Asia and General models only)**
The **VOLTAGE SELECTOR** on the rear panel of this unit must be set for your local main voltage **BEFORE** plugging into the AC main supply. Voltages are:
Asia model 220/230–240 V AC, 50/60 Hz
General model 110/120/220/230–240 V AC, 50/60 Hz

WARNING

TO REDUCE THE RISK OF FIRE OR ELECTRIC SHOCK, DO NOT EXPOSE THIS UNIT TO RAIN OR MOISTURE.

This unit is not disconnected from the AC power source as long as it is connected to the wall outlet, even if this unit itself is turned off. This state is called the standby mode. In this state, this unit is designed to consume a very small quantity of power.

FOR CANADIAN CUSTOMERS

To prevent electric shock, match wide blade of plug to wide slot and fully insert.
This Class B digital apparatus complies with Canadian ICES-003.

IMPORTANT

Please record the serial number of this unit in the space below.
MODEL:
Serial No.:
The serial number is located on the rear of the unit.
Retain this Owner's Manual in a safe place for future reference.

We Want You Listening For A Lifetime

YAMAHA and the Electronic Industries Association's Consumer Electronics Group want you to get the most out of your equipment by playing it at a safe level. One that lets the sound come through loud and clear without annoying blaring or distortion – and, most importantly, without affecting your sensitive hearing.

Since hearing damage from loud sounds is often undetectable until it is too late, YAMAHA and the Electronic Industries Association's Consumer Electronics Group recommend you to avoid prolonged exposure from excessive volume levels.



CONTENTS

INTRODUCTION

FEATURES	2
GETTING STARTED	3
Supplied accessories	3
Installing batteries in the remote control	3
CONTROLS AND FUNCTIONS	4
Front panel	4
Remote control.....	6
Using the remote control	7
Front panel display	8
Rear panel	10

PREPARATION

SPEAKER SETUP	11
Speaker placement.....	11
Speaker connections	12
CONNECTIONS	15
Before connecting components.....	15
Connecting video components.....	16
Connecting audio components.....	19
Connecting the FM and AM antennas	21
Connecting the power supply cord	22
Speaker impedance setting	23
Turning on the power.....	23
AUTO SETUP	24
Introduction.....	24
Optimizer microphone setup.....	24
Starting the setup	25

BASIC OPERATION

PLAYBACK	30
Basic operations.....	30
Selecting sound field programs	32
Selecting input modes.....	37
FM/AM TUNING	39
Automatic and manual tuning.....	39
Presetting stations	40
Selecting preset stations.....	42
Exchanging preset stations	43
XM SATELLITE RADIO TUNING	45
What is XM Satellite Radio?.....	45
XM Satellite Radio connections	45
XM Satellite Radio functions	46
Activating XM Satellite Radio	47
Basic XM Satellite Radio operations.....	48
XM Satellite Radio search modes.....	49
Setting XM Satellite Radio preset channels	52
RECORDING	55

SOUND FIELD PROGRAMS

SOUND FIELD PROGRAM DESCRIPTIONS	56
For movie/video sources.....	56
For music sources	58

ADVANCED OPERATION

ADVANCED OPERATIONS	59
Selecting the OSD mode.....	59
Using the sleep timer	59
Manually adjusting speaker levels.....	60
SET MENU	61
Using SET MENU	63
1 SOUND MENU.....	64
2 INPUT MENU	69
3 OPTION MENU	71
ADVANCED SETUP MENU	73
REMOTE CONTROL FEATURES	75
Control area	75
Setting remote control codes	76
Controlling other components	78
Programming codes from other remote controls	79
Changing source names in the display window.....	80
Clearing function sets	81
Clearing individual functions	82
ZONE 2 (U.S.A., CANADA, AUSTRALIA AND EUROPE MODELS ONLY)	83
Zone 2 connections	83
Remote controlling Zone 2	84

ADDITIONAL INFORMATION

EDITING SOUND FIELD PARAMETERS	86
What is a sound field	86
Changing parameter settings	86
SOUND FIELD PARAMETER DESCRIPTIONS	88
TROUBLESHOOTING	93
RESETTING THE FACTORY PRESETS	98
GLOSSARY	99
Audio formats	99
Sound field programs.....	100
Audio information	100
Video signal information	101
SPECIFICATIONS	102

INTRODUCTION

PREPARATION

BASIC OPERATION

SOUND FIELD PROGRAMS

ADVANCED OPERATION

ADDITIONAL INFORMATION

FEATURES

Built-in 7-channel power amplifier

- ◆ Minimum RMS output power (0.06% THD, 20 Hz to 20 kHz, 8 Ω)
Front: 100 W + 100 W
Center: 100 W
Surround: 100 W + 100 W
Surround back: 100 W + 100 W

Sound field features

- ◆ Proprietary YAMAHA technology for the creation of sound fields
- ◆ Dolby Digital/Dolby Digital EX decoder
- ◆ DTS/DTS-ES Matrix 6.1, Discrete 6.1, DTS Neo:6, DTS 96/24 decoder
- ◆ Dolby Pro Logic/Dolby Pro Logic II/Dolby Pro Logic Ix decoder
- ◆ Virtual CINEMA DSP
- ◆ SILENT CINEMA™

Sophisticated AM/FM tuner

- ◆ 40-station random and direct preset tuning
- ◆ Automatic preset tuning
- ◆ Preset station shifting capability (preset editing)

XM Satellite Radio

- ◆ XM Satellite Radio programming (using the “XM connect and Play digital antenna accessory”, sold separately)

Other features

- ◆ YPAO: YAMAHA Parametric Room Acoustic Optimizer for automatic speaker setup
- ◆ 192-kHz/24-bit D/A converter
- ◆ A SET MENU that provides you with items for optimizing this unit for your audio/video system
- ◆ 8 additional input jacks for discrete multi-channel input
- ◆ PURE DIRECT for pure fidelity sound with analog and PCM sources
- ◆ On-screen display function helpful in controlling this unit
- ◆ S-video signal input/output capability
- ◆ Component video input/output capability
- ◆ Video signal conversion (Composite video ↔ S-video → Component video) capability for monitor out
- ◆ Optical and coaxial digital audio signal jacks
- ◆ Sleep timer
- ◆ Cinema and music night listening modes
- ◆ Remote control with preset remote control codes and “learning” capability
- ◆ Zone 2 custom installation facility (U.S.A., Canada, Australia and Europe models only)

• ❄ indicates a tip for your operation.

- Some operations can be performed by using either the buttons on the main unit or on the remote control. In cases when the button names differ between the main unit and the remote control, the button name on the remote control is given in parentheses.
- This manual is printed prior to production. Design and specifications are subject to change in part as a result of improvements, etc. In case of differences between the manual and product, the product has priority.



Manufactured under license from Dolby Laboratories. “Dolby”, “Pro Logic”, “Surround EX”, and the double-D symbol are trademarks of Dolby Laboratories.

SILENT™
CINEMA

“SILENT CINEMA” is a trademark of YAMAHA CORPORATION.



“DTS”, “DTS-ES”, “Neo:6” and “DTS 96/24” are trademarks of Digital Theater Systems, Inc.



The XM name and related logos are registered trademarks of XM Satellite Radio Inc.

GETTING STARTED

Supplied accessories

Please check that you received all of the following parts.

Remote control

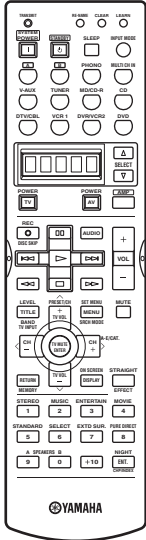

Batteries (4)
(AAA, R03, UM-4)

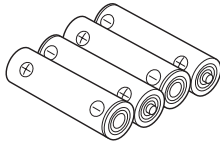

AM loop antenna



Optimizer microphone

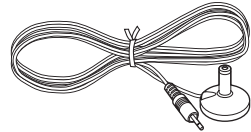

Indoor FM antenna
(U.S.A., Canada, China
and General models)

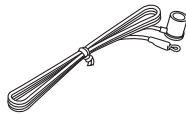

Indoor FM antenna
(Europe, Australia and
Korea models)

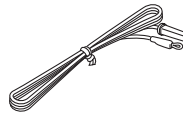

Installing batteries in the remote control

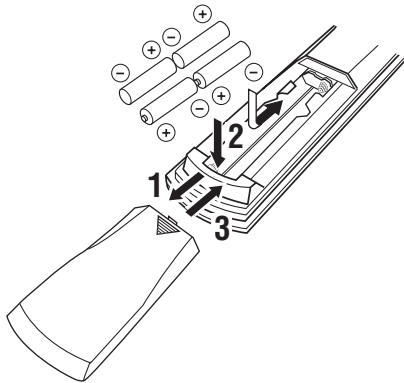

1 Press the ▼ part and slide the battery compartment cover off.

2 Insert four supplied batteries (AAA, R03, UM-4) according to the polarity markings (+ / -) on the inside of the battery compartment.

3 Slide the cover back until it snaps into place.

Notes on batteries

- Change all of the batteries if you notice the following conditions; the operation range of the remote control decreases, the indicator does not flash or its light becomes dim.
- Do not use old batteries together with new ones.
- Do not use different types of batteries (such as alkaline and manganese batteries) together. Read the packaging carefully as these different types of batteries may have the same shape and color.
- If the batteries have leaked, dispose of them immediately. Avoid touching the leaked material or letting it come into contact with clothing, etc. Clean the battery compartment thoroughly before installing new batteries.
- Do not throw away batteries with general house waste; dispose of them correctly in accordance with your local regulations.

If the remote control is without batteries for more than 2 minutes, or if exhausted batteries remain in the remote control, the contents of the memory may be cleared. When the memory is cleared, insert new batteries, set up the remote control code and program any acquired functions that may have been cleared.

CONTROLS AND FUNCTIONS

Front panel

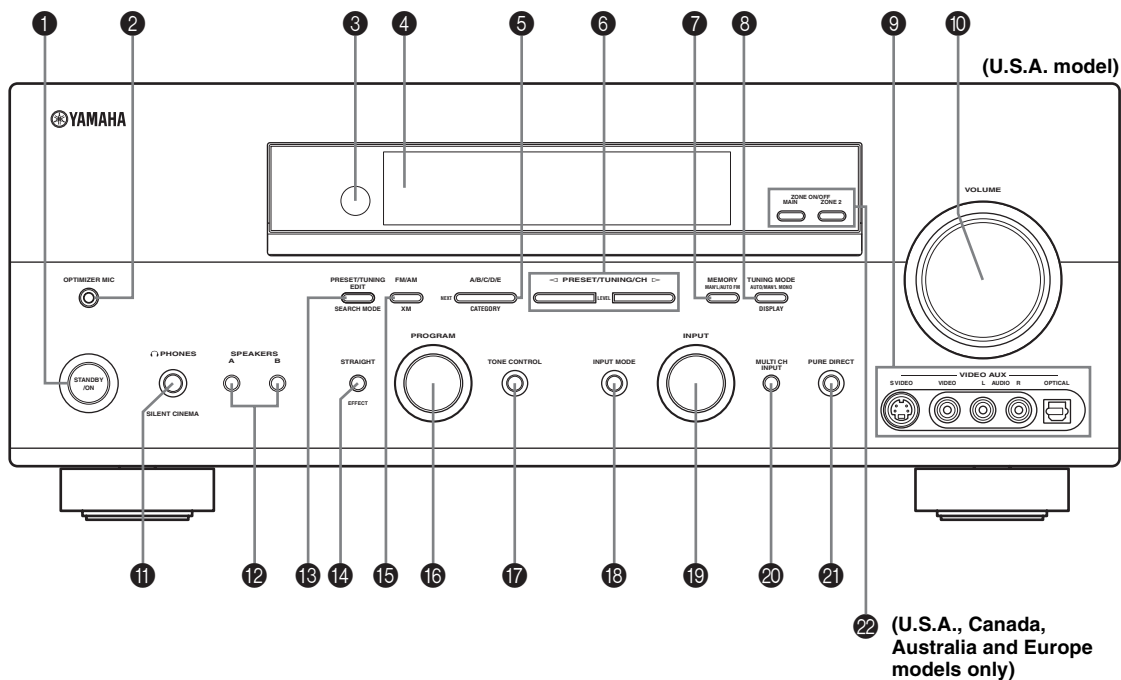

1 STANDBY/ON

Turns on this unit or sets it to the standby mode. When you turn on this unit, you will hear a click and there will be a 4 to 5-second delay before this unit can reproduce sound.

Note

In standby mode, this unit consumes a small amount of power in order to receive infrared-signals from the remote control.

2 OPTIMIZER MIC jack

Use to connect and input audio signals from the supplied microphone for use with the AUTO SETUP function (see page 24).

3 Remote control sensor

Receives signals from the remote control.

4 Front panel display

Shows information about the operational status of this unit.

5 A/B/C/D/E, NEXT, CATEGORY*

Selects one of the 5 preset station groups (A to E) when the unit is in tuner mode.

Selects the speaker channel to be adjusted when the unit is not in tuner mode.

6 PRESET/TUNING/ CH* </>, LEVEL -/+

Selects preset station number 1 to 8 when the colon (:) is displayed next to the band indication in the front panel display when the unit is in tuner mode. Selects the tuning frequency when the colon (:) is not displayed.

Adjusts the level of the speaker channel selected using A/B/C/D/E (NEXT) when the unit is not in tuner mode.

7 MEMORY (MAN'L/AUTO FM)

Stores a station in the memory. Hold down this button for more than 3 seconds to start automatic preset tuning.

8 TUNING MODE (AUTO/MAN'L MONO), DISPLAY*

Switches the tuning mode between automatic (AUTO indicator on) and manual (AUTO indicator off).

9 VIDEO AUX jacks

Input audio and video signals from a portable external source such as a game console. To reproduce source signals from these jacks, select V-AUX as the input source.

10 VOLUME

Controls the output level of all audio channels. This does not affect the REC OUT level.

11 PHONES (SILENT CINEMA) jack

Outputs audio signals for private listening with headphones. When you connect headphones, no signals are output to the PRE OUT jacks or to the speakers. All Dolby Digital and DTS audio signals are mixed down to the left and right headphone channels.

12 SPEAKERS A/B

Turns on or off the set of front speakers connected to the A and/or B terminals on the rear panel each time the corresponding button is pressed.

13 PRESET/TUNING (EDIT), SEARCH MODE*

Switches the function of PRESET/TUNING/CH ◀ / ▶ (LEVEL) between selecting preset station numbers and tuning.

14 STRAIGHT (EFFECT)

Switches the sound fields off or on. When STRAIGHT is selected, input signals (2-channel or multi-channel) are output directly from their respective speakers without effect processing.

15 FM/AM, XM*

Switches the reception band when the unit is in tuner mode.

16 PROGRAM

Use to select sound field programs or adjust the bass/treble balance (in conjunction with TONE CONTROL).

17 TONE CONTROL

Use to adjust the bass/treble balance for the front left and right, center, presence and subwoofer channels (see page 31).

18 INPUT MODE

Sets the priority (AUTO, DTS, ANALOG) for the type of signals received when one component is connected to two or more of this unit's input jacks (see page 37).

19 INPUT selector

Selects the input source you want to listen to or watch.

20 MULTI CH INPUT

Selects the source connected to the MULTI CH INPUT jacks. When selected, the MULTI CH INPUT source takes priority over the source selected with INPUT (or the input selector buttons on the remote control).

21 PURE DIRECT

Turns on or off PURE DIRECT mode (see page 35).

■ U.S.A., Canada, Australia and Europe models only**22 ZONE ON/OFF buttons****MAIN**

Switches this unit's operation to control the component in the main room (see page 84).

ZONE 2

Switches this unit's operation to control the component in the second room (Zone 2) (see page 84).

* Available only when the unit is in the XM Satellite Radio mode (see page 45).

Remote control

This section describes the function of each control on the remote control used to control this unit. To operate other components, see “REMOTE CONTROL FEATURES” on page 75.

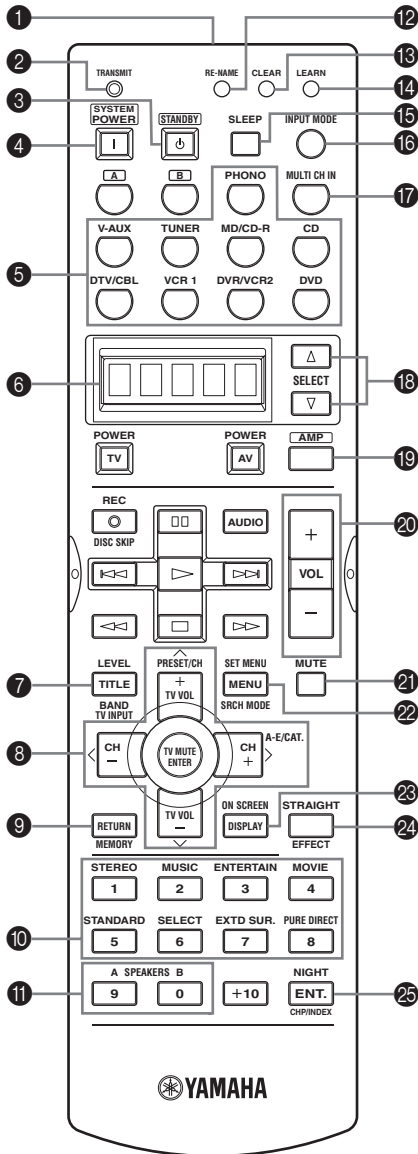

1 Infrared window

Outputs infrared control signals. Aim this window at the component you want to operate.

2 TRANSMIT indicator

Flashes while the remote control is sending signals.

3 STANDBY

Sets this unit in the standby mode.

4 SYSTEM POWER

Turns on the power of this unit.

5 Input selector buttons

Select the input source and change the control area.

6 Display window

Shows the name of the selected source component that you can control.

7 LEVEL, BAND

Selects the speaker channel to be adjusted and sets the level.

Switches the reception band when the unit is in tuner mode.

8 Cursor buttons $\wedge / \vee / \langle / \rangle / \text{ENTER}$

Use to select and adjust sound field program parameters or SET MENU items.

Press \langle / \rangle to select a preset station group (A to E) when the unit is in tuner mode.

Press \wedge / \vee to select a preset station number (1 to 8) when the unit is in tuner mode.

9 RETURN, MEMORY*

Returns to the previous menu level when adjusting the SET MENU parameters.

10 Sound field program/numeric buttons

Use to select sound field programs.

Use numbers 1 through 8 to select preset stations when the unit is in tuner mode.

Use SELECT to playback 2-channel sources in multiple channel format (see page 34).

Use EXTND SUR. to switch between 5.1 or 6.1/7.1-channel playback of multi-channel software (see page 33).

Use PURE DIRECT to turn on or off PURE DIRECT mode (see page 35).

11 SPEAKERS A/B

Use to turn on or off the set of front speakers connected to the A and/or B terminal on the rear panel each time the corresponding button is pressed.

12 RE-NAME

Use to change the input source name in the display window (see page 80).

13 CLEAR

Use to clear functions acquired when using the learn and rename features, or setting remote control codes (see page 81).

14 LEARN

Use to set up manufacturer codes or program functions from other remote controls (see pages 76 and 79).

15 SLEEP

Sets the sleep timer.

16 INPUT MODE

Sets the priority (AUTO, DTS, ANALOG) for the type of signals received when one component is connected to two or more of this unit's input jacks (see page 37).

17 MULTI CH IN

Selects MULTI CH INPUT when using an external decoder (etc.).

18 SELECT Δ/∇

Selects another component that you can control independently of the input component selected with the input selector buttons.

19 AMP

Selects the AMP mode. You must select the AMP mode to control the main unit.

20 VOL +/-

Increases or decreases the volume level.

21 MUTE

Mutes the sound. Press again to restore the audio output to the previous volume level.

22 SET MENU, SRCH MODE*

Activates the SET MENU function.

23 ON SCREEN

Selects the display mode of the on-screen display (OSD) this unit sends to your video monitor.

24 STRAIGHT (EFFECT)

Switches the sound fields off or on. When STRAIGHT is selected, input signals (2-channel or multi-channel) are output directly from their respective speakers without effect processing.

25 NIGHT, ENT.*

Turns on or off the night listening modes (see page 35).

* Available only when the unit is in the XM Satellite Radio mode (see page 45).

Using the remote control

The remote control transmits a directional infrared beam. Be sure to aim the remote control directly at the remote control sensor on the main unit during operation.

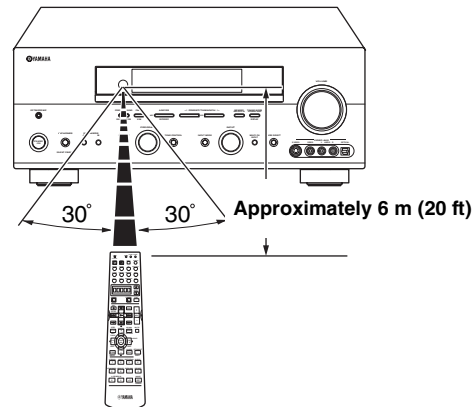
**Handling the remote control**

- Do not spill water or other liquids on the remote control.
- Do not drop the remote control.
- Do not leave or store the remote control in the following types of conditions:
 - places of high humidity, such as near a bath
 - places of high temperature, such as near a heater or stove
 - extremely low temperatures
 - dusty places

Front panel display

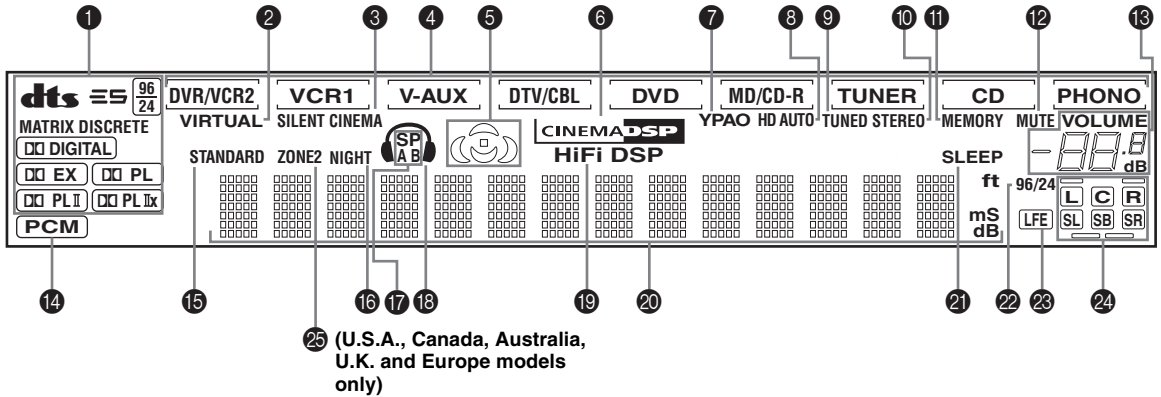

1 Decoder indicators

When any of this unit's decoders function, the respective indicator lights up.

2 VIRTUAL indicator

Lights up when Virtual CINEMA DSP is active (see page 36).

3 SILENT CINEMA indicator

Lights up when headphones are connected and a sound field program is selected (see page 31).

4 Input source indicators

A cursor lights to show the current input source.

5 Sound field indicators

Light to indicate the active DSP sound fields.

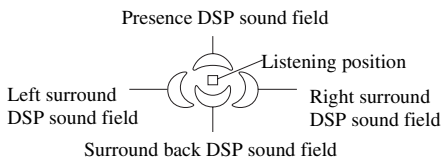

6 CINEMA DSP indicator

Lights up when you select a CINEMA DSP sound field program.

7 YPAO indicator

Lights up during the auto setup procedure and when the auto setup speaker settings are used without any modifications.

8 AUTO indicator

Lights up when this unit is in automatic tuning mode.

9 TUNED indicator

Lights up when this unit is tuned into a station.

10 STEREO indicator

Lights up when this unit is receiving a strong signal for an FM stereo broadcast while the AUTO indicator is lit.

11 MEMORY indicator

Flashes to show that a station can be stored.

12 MUTE indicator

Flashes while the MUTE function is on.

13 VOLUME level indication

Indicates the current volume level.

14 PCM indicator

Lights up when this unit is reproducing PCM (Pulse Code Modulation) digital audio signals.

15 STANDARD

Lights up when a decoder is selected (see page 34).

16 NIGHT indicator

Lights up when you select night listening mode.

17 SP A B indicators

Light up according to the set of front speakers selected. Both indicators light up when both sets of speakers are selected.

18 Headphones indicator

Lights up when headphones are connected.

19 HiFi DSP indicator

Lights up when you select a HiFi DSP sound field program.

20 Multi-information display

Shows the current sound field program name and other information when adjusting or changing settings.

⑳ SLEEP indicator

Lights up while the sleep timer is on.

㉑ 96/24 indicator

Lights up when a DTS 96/24 signal is input to this unit.

㉒ LFE indicator

Lights up when the input signal contains the LFE signal.

㉓ Input channel indicators

Indicate the channel components of the current digital input signal.

■ U.S.A., Canada, Australia and Europe model only**㉔ ZONE 2 indicator**

Lights up when Zone 2 power is on.

Rear panel

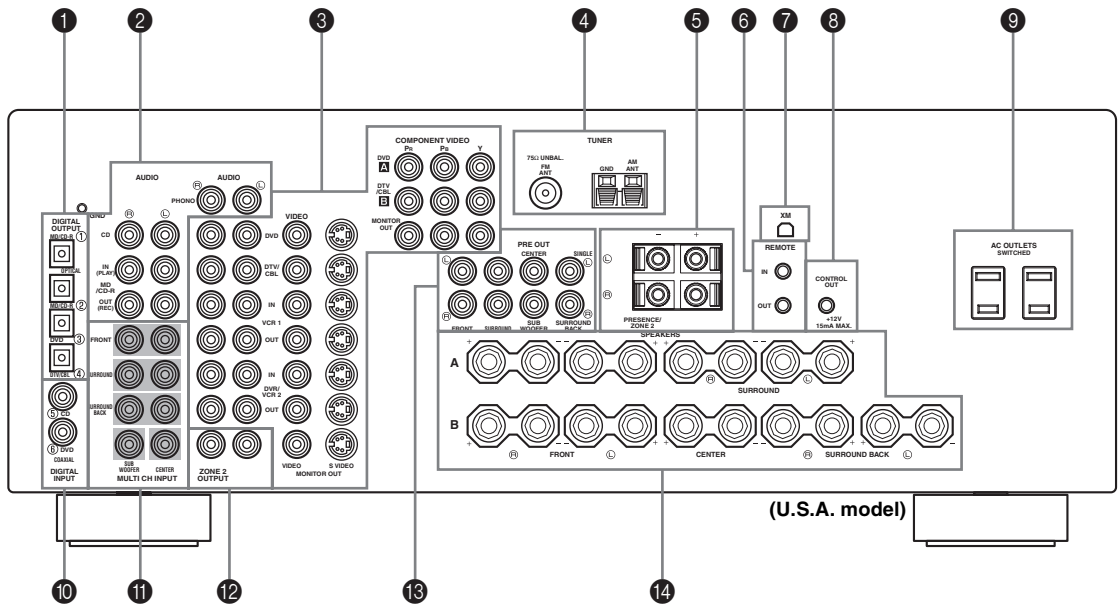

1 DIGITAL OUTPUT jacks

See page 19 for details.

2 Audio component jacks

See page 19 for connection information.

3 Video component jacks

See pages 16 and 18 for connection information.

4 Antenna terminals (except U.K. model)

See page 21 for connection information.

5 PRESENCE/ZONE 2 speaker terminals (U.S.A., Canada, Australia and Europe models)

PRESENCE speaker terminals (other models)

See page 13 for connection information.

6 REMOTE IN/OUT jacks (U.S.A., Canada, Australia and Europe models only)

See page 83 for details.

7 XM jack

See page 45 for connection information.

8 CONTROL OUT jack (U.S.A., Canada, Australia, U.K. and Europe models only)

This is a control expansion terminal for commercial use.

9 AC OUTLET(S)

Use to supply power to your other A/V components (see page 22).

10 DIGITAL INPUT jacks

See pages 16, 18 and 19 for details.

11 MULTI CH INPUT jacks

See page 17 for connection information.

12 ZONE 2 OUTPUT jacks (U.S.A., Canada, Australia and Europe models only)

These jacks output analog signals only. See page 83 for details.

TUNER INPUT jacks (U.K. model only)

13 PRE OUT jacks

See page 20 for connection information.

14 Speaker terminals

See page 13 for connection information.

General models only

VOLTAGE SELECTOR

See page 22 for details.

SPEAKER SETUP

Speaker placement

The speaker layout below shows the standard ITU-R* speaker setting. You can use it to enjoy CINEMA DSP and multi-channel audio sources.

* ITU-R is the radio communication sector of the ITU (International Telecommunication Union).

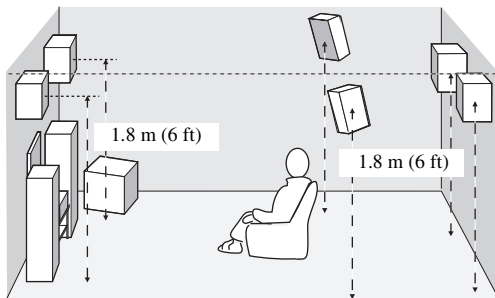
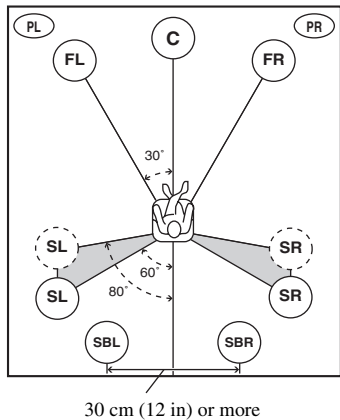

Front speakers (FR and FL)

The front speakers are used for the main source sound plus effect sounds. Place these speakers an equal distance from the ideal listening position. The distance of each speaker from each side of the video monitor should be the same.

Center speaker (C)

The center speaker is for the center channel sounds (dialog, vocals, etc.). If for some reason it is not practical to use a center speaker, you can do without it. Best results, however, are obtained with the full system. Align the front face of the center speaker with the front face of your video monitor. Place the speaker centrally between the front speakers and as close to the monitor as possible, such as directly over or under it.

Surround speakers (SR and SL)

The surround speakers are used for effect and surround sounds. Place these speakers behind your listening position, facing slightly inwards, about 1.8 m (6 ft) above the floor.

Surround back speakers (SBR and SBL)

The surround back speakers supplement the surround speakers and provide for more realistic front-to-back transitions. Place these speakers directly behind the listening position and at the same height as the surround speakers. They should be positioned at least 30 cm (12 in) apart. Ideally, they should be positioned at the same width as the front speakers.

Subwoofer

The use of a subwoofer, such as the YAMAHA Active Servo Processing Subwoofer System, is effective not only for reinforcing bass frequencies from any or all channels, but also for high fidelity reproduction of the LFE (low-frequency effect) channel included in Dolby Digital and DTS software. The position of the subwoofer is not so critical, because low bass sounds are not highly directional. But it is better to place the subwoofer near the front speakers. Turn it slightly toward the center of the room to reduce wall reflections.

Presence speakers (PR and PL)

Presence speakers supplement the sound from the front speakers with extra ambient effects produced by CINEMA DSP (see page 56). These effects include sounds that filmmakers intend to locate a little farther back behind the screen in order to create more theater-like ambience. Place these speakers at the front of the room about 0.5 - 1 m (1 - 3 ft) outside the front speakers, facing slightly inwards, and about 1.8 m (6 ft) above the floor.

Speaker connections

Be sure to connect the left channel (L), right channel (R), “+” (red) and “-” (black) properly. If the connections are faulty, no sound will be heard from the speakers, and if the polarity of the speaker connections is incorrect, the sound will be unnatural and lack bass.

CAUTION

- If you will use 4 or 6 ohm speakers, be sure to set this unit’s speaker impedance setting to 4 ohms before using (see page 23).
- Before connecting the speakers, make sure that the power of this unit is off.
- Do not let the bare speaker wires touch each other or do not let them touch any metal part of this unit. This could damage this unit and/or speakers.
- Use magnetically shielded speakers. If this type of speakers still creates the interference with the monitor, place the speakers away from the monitor.

A speaker cord is actually a pair of insulated cables running side by side. One cable is colored or shaped differently, perhaps with a stripe, groove or ridges. Connect the striped (grooved, etc.) cable to the “+” (red) terminals on this unit and your speaker. Connect the plain cable to the “-” (black) terminals.

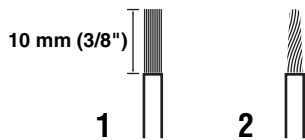

- 1 Remove approximately 10 mm (3/8") of insulation from the end of each speaker cable.
- 2 Twist the exposed wires of the cable together to prevent short circuits.
- 3 Unscrew the knob.
- 4 Insert one bare wire into the hole in the side of each terminal.

- 5 Tighten the knob to secure the wire.

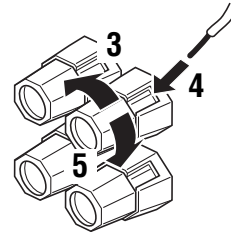

Red: positive (+)
Black: negative (-)

Connecting to PRESENCE/ZONE 2 or PRESENCE speaker terminals

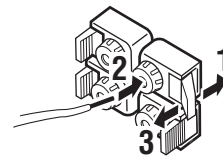

- 1 Open the tab.
- 2 Insert one bare wire into the hole of each terminal.
- 3 Return the tab to secure the wire.

Banana plug connections

(With the exception of U.K. and Europe models)
First, tighten the knob and then insert the banana plug connector into the end of the corresponding terminal.

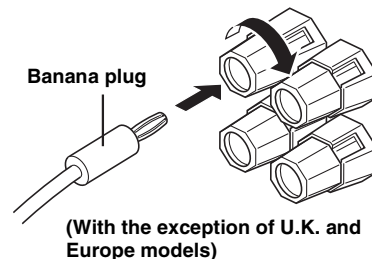

You can also use banana plugs with the PRESENCE/ZONE 2 and PRESENCE speaker terminals. Open the tab, then insert one banana plug connector into the hole of each terminal. Do not attempt to close the tabs after connecting the banana plugs.

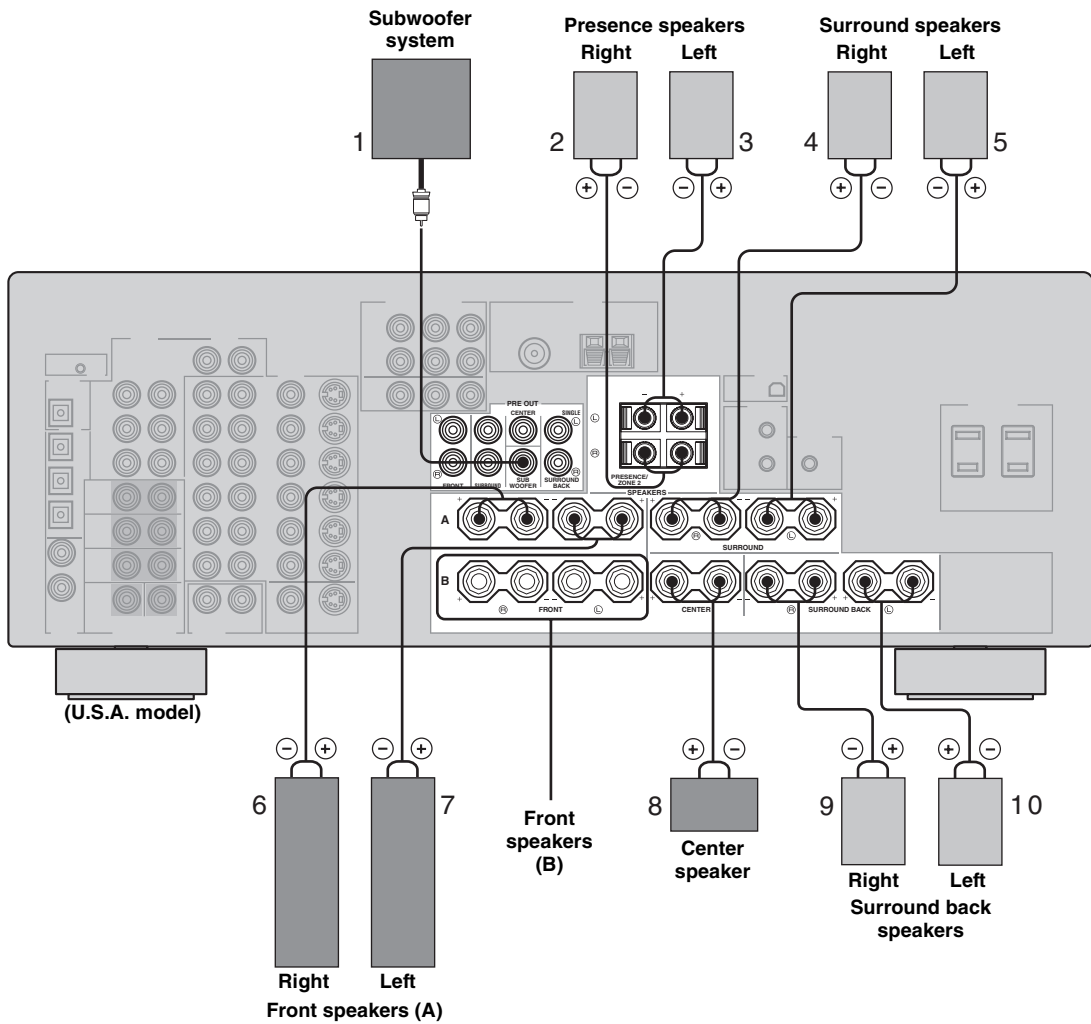

You can connect both surround back and presence speakers to this unit, but they do not output sound simultaneously.

- The surround back speakers output the surround back channel included in Dolby Digital EX and DTS-ES software and only operate when the Dolby Digital EX, DTS-ES or Dolby Pro Logic IIx decoder is turned on.
- The presence speakers output ambient effects created by the DSP sound fields. They do not output sound when other sound fields are selected.

■ FRONT terminals

Connect one or two speaker systems (6, 7) to these terminals. If you use only one speaker system, connect it to the FRONT A or B terminals.

■ CENTER terminals

Connect a center speaker (8) to these terminals.

■ SURROUND terminals

Connect surround speakers (4, 5) to these terminals.

■ SUBWOOFER jack

Connect a subwoofer with built-in amplifier (1), such as the YAMAHA Active Servo Processing Subwoofer System, to this jack.

■ SURROUND BACK terminals

Connect surround back speakers (9, 10) to these terminals. If you only connect one surround back speaker, connect it to the left (L) terminals.

■ PRESENCE terminals

Connect presence speakers (2, 3) to these terminals.

* If you are using either the U.S.A., Canada, Australia, U.K. or Europe model, you can also use these speakers as Zone 2 speakers (see page 72).

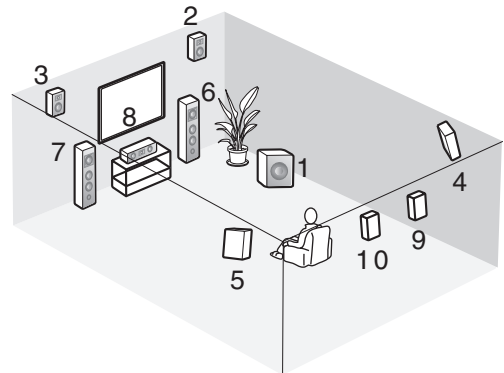

Speaker layout

CONNECTIONS

Before connecting components

CAUTION

Do not connect this unit or other components to the mains power until all connections between components are complete.

■ Cable indications

For analog signals

left analog cables



right analog cables



For digital signals

optical cables



coaxial cables



For video signals

video cables



S-video cables



component video cables

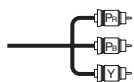

■ Analog jacks

You can input analog signals from audio components by connecting audio pin cable to the analog jacks on this unit. Connect red plugs to the right jacks and white plugs to the left jacks.

■ Digital jacks

This unit has digital jacks for direct transmission of digital signals through either coaxial or fiber optic cables. You can use the digital jacks to input PCM, Dolby Digital and DTS bitstreams. When you connect components to both the COAXIAL and OPTICAL jacks, priority is given to the input signals from the COAXIAL jack. All digital input jacks are compatible with 96-kHz sampling digital signals.

Note

This unit handles digital and analog signals independently. Thus audio signals input to the analog jacks are only output to the analog OUT (REC) jacks. Likewise audio signals input to the digital (OPTICAL or COAXIAL) jacks are only output to the DIGITAL OUTPUT jack.

Dust protection cap

Pull out the cap from the optical jack before you connect the fiber optic cable. Do not discard the cap. When you are not using the optical jack, be sure to put the cap back in place. This cap protects the jack from dust.

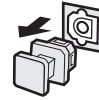

■ Video jacks

This unit has three types of video jacks. Connection depends on the availability of input jacks on your monitor. The signals input through the S VIDEO jacks on this unit are automatically converted for output through the VIDEO jacks. When VIDEO CONV. is set to ON (see page 71), signals input through the VIDEO jacks can be output through the S VIDEO and COMPONENT VIDEO jacks. Likewise, signals input through the S VIDEO jacks can also be output through the COMPONENT VIDEO jacks.



VIDEO jacks

For conventional composite video signals.

S VIDEO jacks

For S-Video signals, separated into luminance (Y) and color (C) video signals to achieve high-quality color reproduction.

COMPONENT VIDEO jacks

For component signals, separated into luminance (Y) and color difference (PB, PR) to provide the best quality in picture reproduction.

Signal flow inside this unit

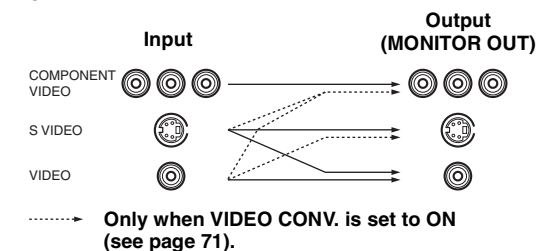

Note

When signals are input through both the S VIDEO and VIDEO jacks, signals input through the S VIDEO jack have priority.

Connecting video components

■ Connections for DVD playback

Note

Be sure to connect your video source components in the same way you connect your video monitor to this unit if VIDEO CONV. (see page 71) is set to OFF. For example, if you connect your video monitor to this unit using a VIDEO connection, connect your video source components to this unit using the VIDEO connections. (Even when V CONV. is set to OFF, S-video signals input from your video source component are automatically converted to composite signals in this unit.)

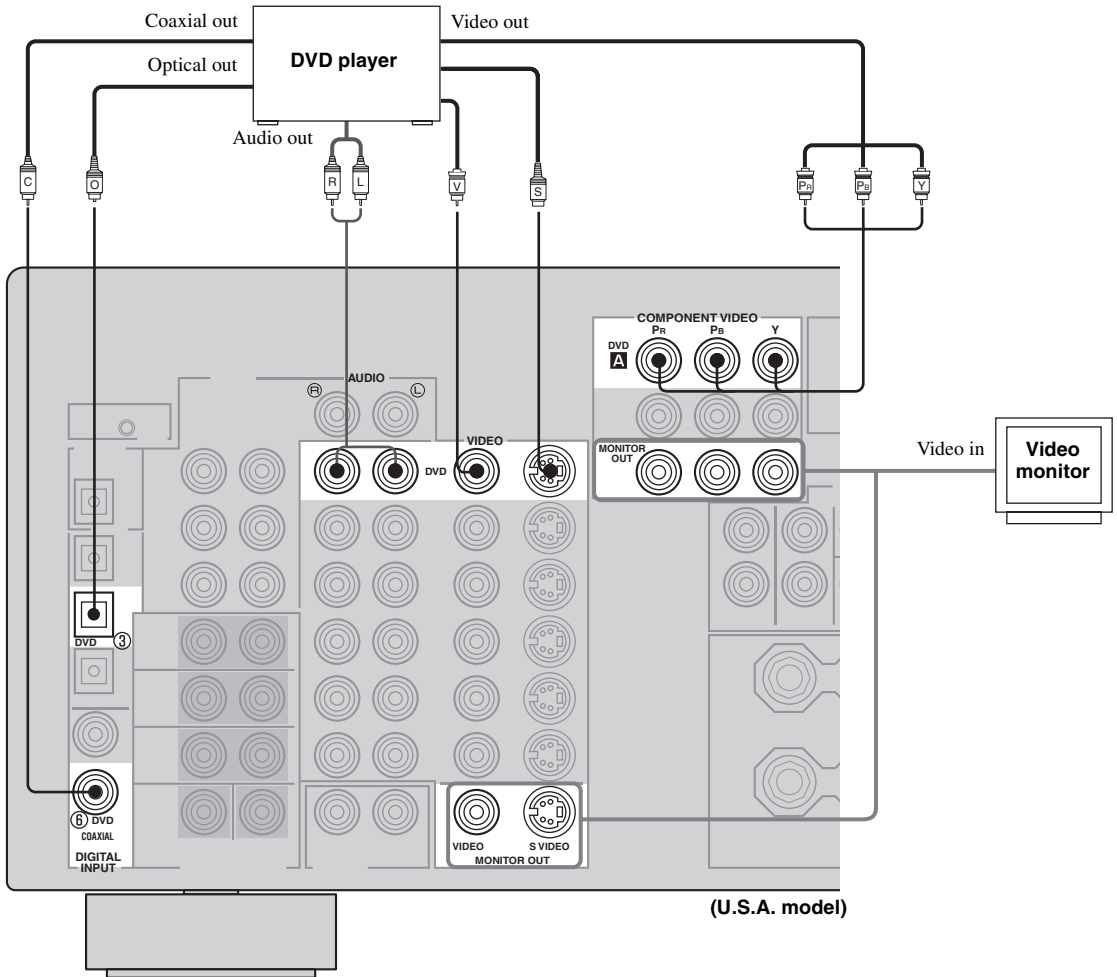

■ Connecting to the MULTI CH INPUT jacks

This unit is equipped with 8 additional input jacks (left and right FRONT, CENTER, left and right SURROUND, left and right SURROUND BACK and SUB WOOFER) for discrete multi-channel input from a multi-format player, external decoder, sound processor or pre-amplifier.

Connect the output jacks on your multi-format player or external decoder to the MULTI CH INPUT jacks. Be sure to match the left and right outputs to the left and right input jacks for the front and surround channels.

For 6-channel input

(U.S.A. model)

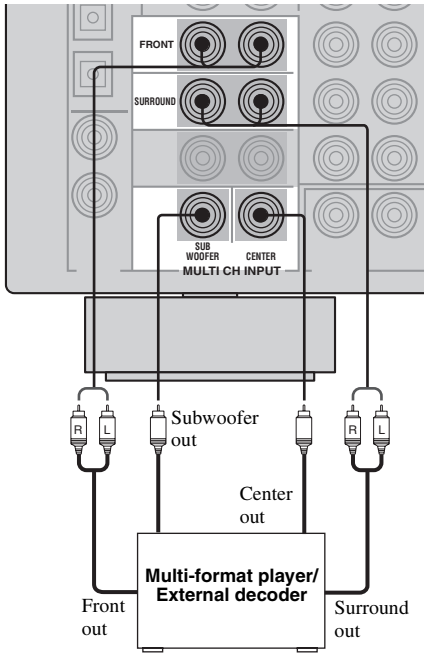

For 8-channel input

(U.S.A. model)

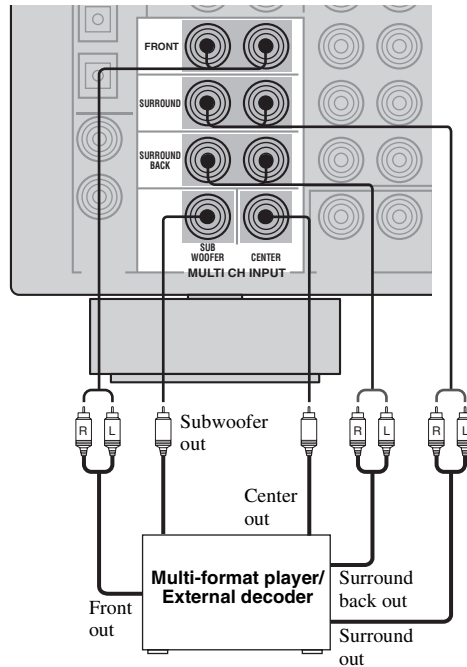

PREPARATION

Notes

- When you select MULTI CH INPUT as the input source, this unit automatically turns off the digital sound field processor, and you cannot select sound field programs.
- This unit does not redirect signals input to the MULTI CH INPUT jacks to accommodate for missing speakers. We recommend that you connect at least a 5.1-channel speaker system before using this feature.
- When headphones are used, only front left and right channels are output.

■ Connections for other video components

Notes

- Be sure to connect your video source components in the same way you connect your video monitor to this unit if VIDEO CONV. (see page 71) is set to OFF. For example, if you connect your video monitor to this unit using a VIDEO connection, connect your video source components to this unit using the VIDEO connections.
- Converted video signals are only output to MONITOR OUT jacks. When recording, you must make the same type of video connections (i.e., S-video) between each component.

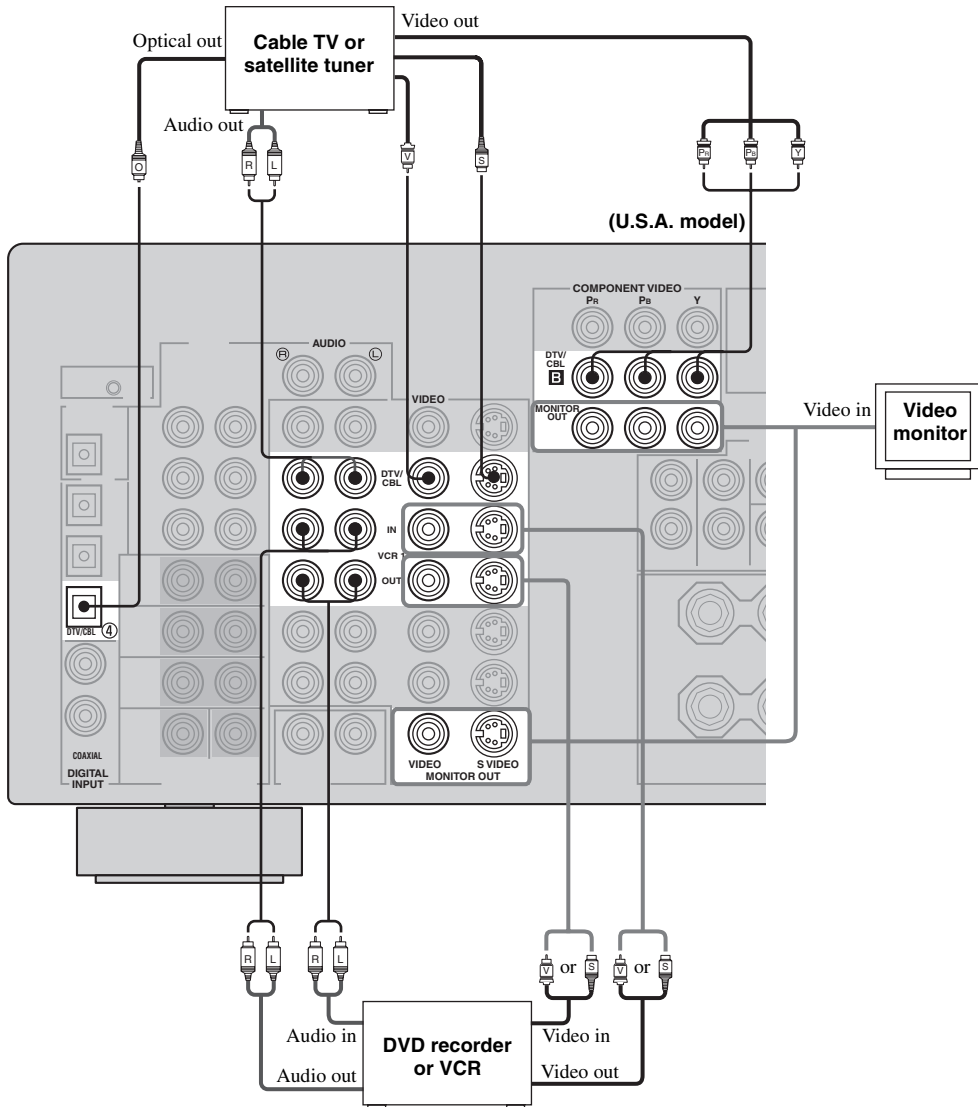

■ VIDEO AUX jacks (on the front panel)

Use these jacks to connect any video source, such as a game console or video camera, to this unit.

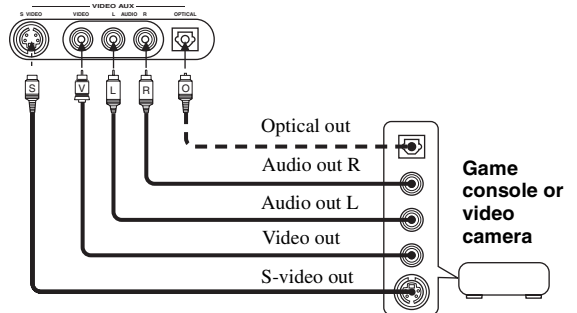

Connecting audio components

■ Connections for audio components

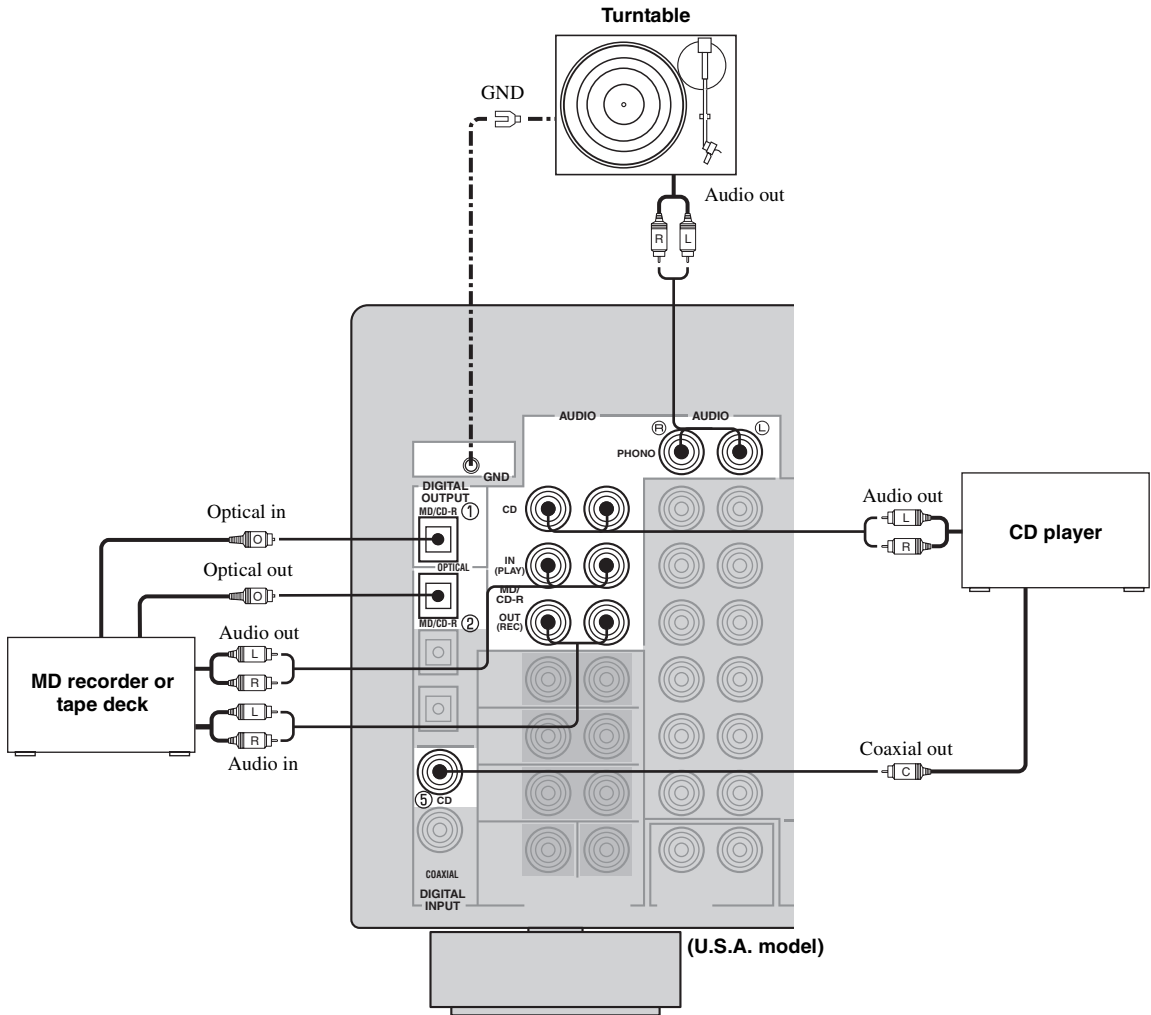

PREPARATION

■ Connecting a turntable

PHONO jacks are for connecting a turntable with an MM or high-output MC cartridge. If you have a turntable with a low-output MC cartridge, use an in-line boosting transformer or MC-head amplifier when connecting to these jacks.



Connect your turntable to the GND terminal to reduce noise in the signal. However you may hear less noise without the connection to the GND terminal for some record players.

■ Connecting to an external amplifier

If you want to increase the power output to the speakers, or want to use another amplifier, connect an external amplifier to the PRE OUT jacks as follows.

Notes

- When audio pin plugs are connected to the PRE OUT jacks for output to an external amplifier, do not make connections to the corresponding SPEAKERS terminals. Set the volume of the amplifier connected to this unit to the maximum.
- The signals output through the FRONT PRE OUT and CENTER PRE OUT jacks are affected by the TONE CONTROL settings.
- If SPEAKERS A is turned off and SP B is set to ZONE B (see page 72), signals will only be output from the FRONT PRE OUT jacks.

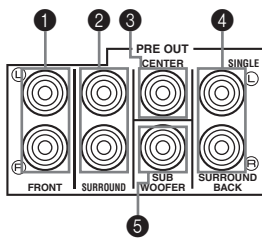

❶ FRONT PRE OUT jacks

Front channel line output jacks.

❷ SURROUND PRE OUT jacks

Surround channel line output jacks.

❸ CENTER PRE OUT jack

Center channel line output jack.

❹ SURROUND BACK PRE OUT jacks

Surround back or presence channel line output jacks.

❺ SUBWOOFER PRE OUT jack

Connect a subwoofer with built-in amplifier, such as the YAMAHA Active Servo Processing Subwoofer System, to this jack.

Notes

- Each PRE OUT jack outputs the same channel signals as the corresponding speaker terminals.
- Adjust the volume level of the subwoofer with the control on the subwoofer. It is also possible to adjust the volume level using the remote control (see “Manually adjusting speaker levels” on page 60).
- Some signals may not be output from the SUBWOOFER PRE OUT jack depending on the SPEAKER SET (see page 64) and LFE/BASS OUT (see page 65) settings.

Connecting the FM and AM antennas

Both FM and AM indoor antennas are included with this unit. In general, these antennas should provide sufficient signal strength. Connect each antenna correctly to the designated terminals.

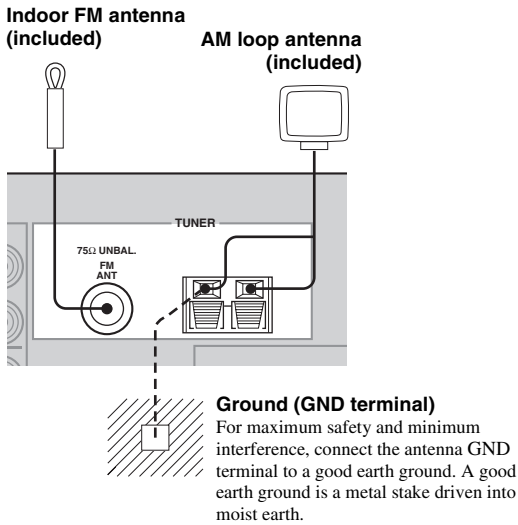

■ FREQUENCY STEP (General model only)

Be sure to set the frequency step according to the frequency spacing in your area (see page 73).

Notes

- The AM loop antenna should be placed away from this unit.
- The AM loop antenna should always be connected, even if an outdoor AM antenna is connected to this unit.
- A properly installed outdoor antenna provides clearer reception than an indoor one. If you experience poor reception quality, an outdoor antenna may improve the quality. Consult the nearest authorized YAMAHA dealer or service center about outdoor antennas.

■ Connecting the AM loop antenna

1 Set up the AM loop antenna, then connect it to the terminals on this unit.

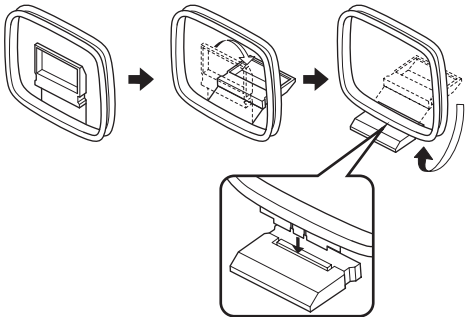

2 Press and hold the tab to insert the AM loop antenna lead wires into the AM ANT and GND terminals.

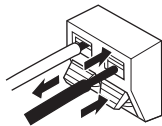

3 Orient the AM loop antenna for the best reception.

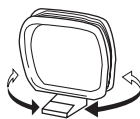

Connecting the power supply cord

■ Connecting the AC power cord

Plug the power cord into an AC wall outlet.

■ AC OUTLET(S) (SWITCHED)

U.K. and Australia models 1 outlet
 Korea model None
 Other models 2 outlets

Use these outlets to connect the power cords from your other components to this unit. Power to the AC OUTLET(S) is controlled by this unit's STANDBY/ON (or SYSTEM POWER and STANDBY). The outlet(s) supply power to any connected component whenever this unit is turned on. For information on the maximum power (total power consumption of components), see "SPECIFICATIONS" on page 102.

■ VOLTAGE SELECTOR (General model only)

The VOLTAGE SELECTOR on the rear panel of this unit must be set for your local main voltage BEFORE plugging into the AC main supply. Voltages are:

Asia model 220/230–240 V AC, 50/60 Hz
 General model 110/120/220/230–240 V AC, 50/60 Hz

■ Memory back-up

The memory back-up circuit prevents the stored data from being lost even if this unit is in the standby mode.

However if the power cord is disconnected from the AC wall outlet, or the power supply is cut for more than one week, the stored data will be lost.

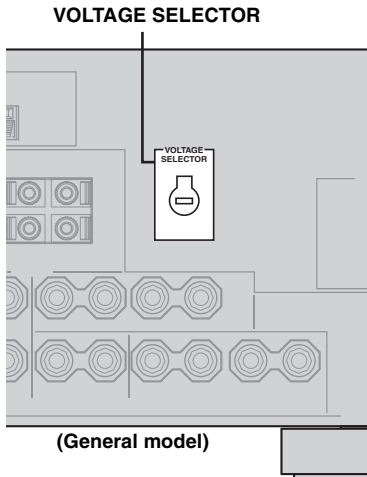

Speaker impedance setting

CAUTION

If you are using 4 or 6 ohm speakers, set the impedance to 4 or 6 ohms as follows before turning on the power.

Be sure this unit is in the standby mode.

- 1 Turn off the power to this unit, and while holding down STRAIGHT (EFFECT), press STANDBY/ON.

This unit turns on, and "SP IMP." appears in the front panel display.

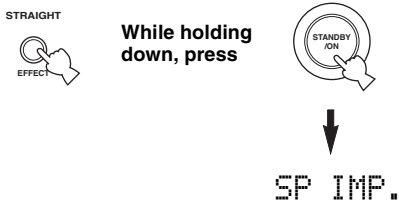

- 2 Press STRAIGHT (EFFECT) repeatedly to select "4 Ω MIN".



- 3 Press STANDBY/ON to turn off the power.



The setting you made is reflected the next time this unit's power is turned on.

Turning on the power

When all connections are complete, turn on the power of this unit.

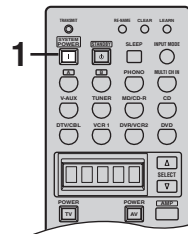
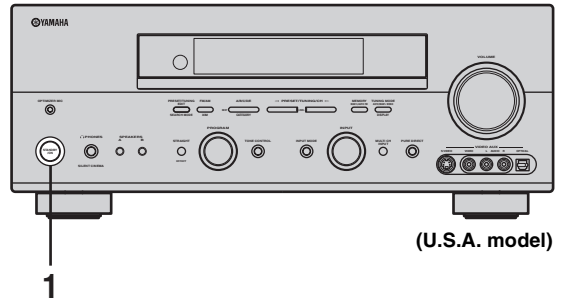

- 1 Press STANDBY/ON (or SYSTEM POWER on the remote control) to turn on the power of this unit.



Front panel

or



Remote control

- 2 Turn on the video monitor connected to this unit.

AUTO SETUP

Introduction

This receiver employs YAMAHA Parametric Room Acoustic Optimizer (YPAO) technology which lets you avoid troublesome listening-based speaker setup and achieves highly accurate sound adjustments. The supplied optimizer microphone collects and analyzes the sound your speakers produce in your actual listening environment.

Notes

- Please be advised that it is normal for loud test tones to be output during the auto setup procedure.
- If auto setup stops and error messages appear on the screen, follow the troubleshooting on page 28.

YPAO performs the following checks and makes appropriate adjustments to give you the best possible sound from your system.

WIRING:

Checks which speakers are connected and the polarity of each speaker.

SIZE:

Checks the speakers frequency response and sets the crossover/high cut frequency for the subwoofer to improve the sound relationship between the speakers and the subwoofer.

DISTANCE:

Checks the distance of each speaker from the listening position and adjusts the delay of each channel so that the sound from each speaker reaches the listening position at the same time. Also checks the phase of each speaker.

EQUALIZING:

Adjusts frequency and levels of each channel's parametric equalizer to reduce coloration across the channels and create a cohesive sound field. This is particularly important if you use different brands or sizes of speakers for some channels or have a room with unique sonic characteristics.

YPAO equalizing calibration incorporates three parameters (frequency, level and Q factor) for each of the seven bands in its parametric equalizer to provide highly precise automatic adjustment of frequency characteristics.

LEVEL:

Checks and adjusts the sound level (volume) of each speaker.

Optimizer microphone setup

- 1 Connect the supplied optimizer microphone to the OPTIMIZER MIC jack on the front panel.**

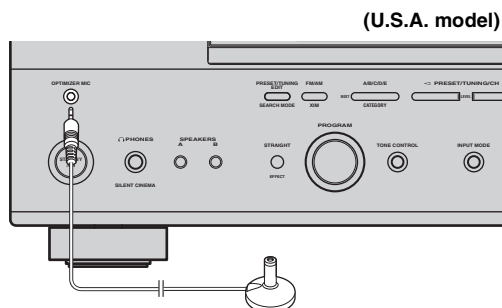

Notes

- After you have completed the auto setup procedure, be sure to disconnect the optimizer microphone.
- The optimizer microphone is sensitive to heat.
 - Keep it away from direct sunlight.
 - Do not place it on top of this unit.

- 2 Place the optimizer microphone on a flat level surface with the omni-directional microphone head upward, at your normal listening position.**

If possible, use a tripod (etc.) to affix the optimizer mic at the same height as your ears would be when you are seated in your listening position.

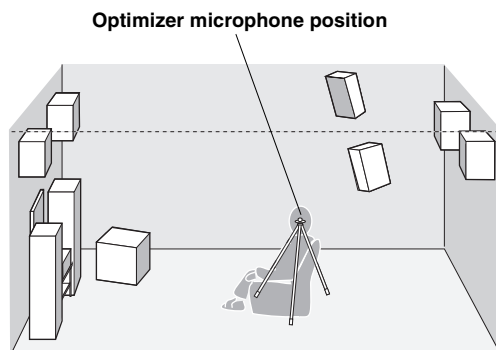

Starting the setup

For best results, make sure the room is as quiet as possible during the auto setup procedure (YPAO). If there is too much ambient noise, the results may not be satisfactory.



If your subwoofer has adjustable volume and crossover/high cut frequency controls, set the volume between 9 and 11 o'clock (as viewed on a conventional clockface) and set the crossover/high cut frequency to the maximum.

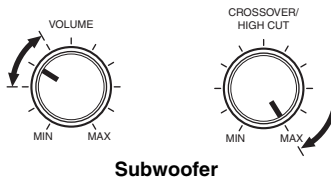

Subwoofer

1 Switch on this unit and your video monitor.
Make sure the OSD is displayed.

2 Press AMP.



3 Press SET MENU.



When MEMORY GUARD is set to ON, you cannot select any other SET MENU items (see page 60).

4 Press ^/∨ to select AUTO SETUP, then press ENTER.

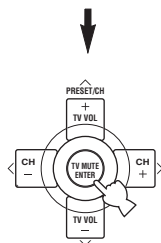
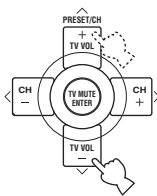

5 Press ^/∨ to select SETUP, then press </> to select the desired setting.



- AUTO** To perform the auto setup procedure (YPAO).
- RELOAD** To reload the last auto setup (YPAO) settings to override any manual changes.
- UNDO** To undo the last auto setup (YPAO) and restore the previous settings.
- DEFAULT** To restore the factory preset (default) setup parameters.



You can choose RELOAD or UNDO only if you have already performed the auto setup procedure.

6 Press ∨ to select "START", then press ENTER to start the setup procedure.

The screen changes as follows.

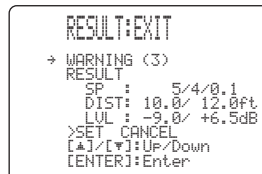
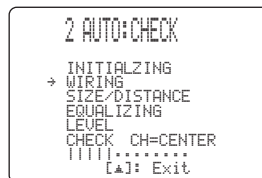

The results displayed in the RESULT:EXIT screen are as follows:

SP	The number of connected speakers displayed in the order: Front/Back/Subwoofer
DIST	The distance of the speakers from this unit displayed in the order: Closest speaker distance/Farthest speaker distance
LVL	The speaker output level displayed in the order: Lowest output level/Highest output level

- If you selected AUTO in step 5, “WAITING” appears when the auto setup procedure is started, then loud test tones are output from each speaker in turn.
- If you selected DEFAULT, RELOAD or UNDO in step 5, no test tones are output.
- If an ERROR screen appears, see “If an error screen appears” on page 26.
- If a WARNING screen appears, see “If a warning screen appears” on page 27.



You can display the detailed result information by using \vee and ENTER to select “RESULT”. In the detailed result information screen, you can switch information by pressing $\wedge / \vee / \langle / \rangle$.

7 Press \langle / \rangle to select SET or CANCEL, then press ENTER to return to the SET MENU screen.

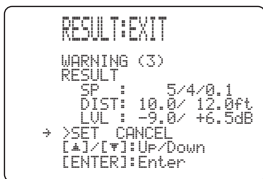

SET	To apply the auto setup (YPAO) settings.
CANCEL	To cancel the auto setup (YPAO) without making any changes.



If you are not satisfied with the result or want to manually adjust each setup parameter, use the manual setup parameters (see page 52).

Notes

- If E-10 appears during testing, restart the procedure from step 3.
- To cancel the auto setup procedure before completion, press \wedge .

■ If an error screen appears

Use $\wedge / \vee / \langle / \rangle$ to select REPLY or EXIT, then press ENTER.

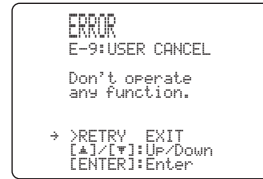

RETRY	To retry the auto setup procedure.
EXIT	To exit auto setup.

■ If a warning screen appears

1 Press ENTER to display detailed information about the warning.

Press </> to switch between warning messages.

```

RESULT:EXIT
→ WARNING (3)
RESULT
  SP :      5/4/0.1
  DIST: 10.0/ 12.0ft
  LVL : -9.0/ +6.5dB
>SET CANCEL
[<]/[>]:UP/Down
[ENTER]:Enter
    
```



```

WARNING:W-1
<OUT OF PHASE>
Reverse Channel
PL
CENTER --
PL PR
SL SR
SBL SBR
[<]/[>]:Select
[ENTER]:Return
    
```

W-1 example screen

For details about each message, see page 29.



- Warnings let you know about potential problems detected during auto setup. Warnings will not cancel the auto setup.
- The number of warnings is displayed to the right of “WARNING”.
- When the warning is not applicable to a speaker, “- -” is displayed.

2 When you are finished, press ENTER to return to the RESULT:EXIT screen.

Continue from step 7 on page 26.

Notes

- If you change speakers, speaker positions, or the layout of your listening environment, perform auto setup again to re-calibrate your system.
- Depending on listening environments, SWFR PHASE:REV appears in AUTO:CHECK and SUBWOOFER PHASE parameter in the SETMENU (see page 66) is automatically set to REVERSE. To select the desired setting, change the SUBWOOFER PHASE parameter in the SETMENU.
- In the DISTANCE results, the distance displayed may be longer than the actual distance depending on the characteristics of your subwoofer.

■ **Troubleshooting for auto setup procedure**

Before auto setup

Error message	Cause	Remedy
Connect MIC	Optimizer microphone is not connected.	<ul style="list-style-type: none"> • Connect the supplied optimizer microphone to the OPTIMIZER MIC jack on the front panel.
Unplug HP	Headphones are connected.	<ul style="list-style-type: none"> • Unplug the headphones.

Errors during auto setup

Error message	Cause	Remedy
E-1:NO FRONT SP	Front L/R channel signal(s) is (are) not detected.	<ul style="list-style-type: none"> • Select the front speakers with SPEAKERS A/B. • Check the front left and right speaker connections. • Turn on the power to the external amplifier (when the front speaker signals are output from an external amplifier).
E-2:NO SURR. SP	Only one surround channel signal is detected.	<ul style="list-style-type: none"> • Check the surround speaker connections.
E-3:NO PRES. SP	Only one presence channel signal is detected.	<ul style="list-style-type: none"> • Check the presence speaker connections.
E-4:SBR->SBL	Only right surround back channel signal is detected.	<ul style="list-style-type: none"> • Connect the surround back speaker to the LEFT SURROUND BACK SPEAKERS terminal if you only have one surround back speaker.
E-5:NOISY	Background noise is too loud.	<ul style="list-style-type: none"> • Try the auto setup procedure in a quiet environment. • Turn off noisy electric equipment like air conditioners (etc.) or move them away from the optimizer microphone.
E-6:CHECK SUR.	Surround back speaker(s) is (are) connected, though surround L/R speakers are not.	<ul style="list-style-type: none"> • Connect surround speakers when you use (a) surround back speaker(s). • Check the surround speaker connections.
E-7:NO MIC	The optimizer microphone was unplugged during the auto setup procedure.	<ul style="list-style-type: none"> • Do not touch the optimizer microphone during the auto setup procedure.
E-8:NO SIGNAL	The optimizer microphone does not detect test tones.	<ul style="list-style-type: none"> • Check the microphone setting. • Check the speaker connections and placement.
E-9:USER CANCEL	The auto setup procedure was cancelled due to user activity.	<ul style="list-style-type: none"> • Perform the auto setup procedure again. Do not adjust VOLUME (etc.) during the auto setup procedure.
E-10:INTERNAL ERROR	A DSP communication error or hangup occurred.	<ul style="list-style-type: none"> • Perform the auto setup procedure again.

Warnings after auto setup

Press </> to display detailed information about individual warnings.

Warning message	Cause	Remedy
W-1:OUT OF PHASE	Speaker polarity is not correct. This message may appear depending on the speakers even when the speakers are connected correctly.	<ul style="list-style-type: none"> • Check the speaker connections for proper polarity (+ / -).
W-2:OVER 24m	The distance between the speaker and the listening position is 24 m (80 ft) or more.	<ul style="list-style-type: none"> • Move the speaker closer to the listening position. • Check the speaker connections for proper polarity (+ / -).
W-3:LEVEL ERROR	The difference of volume level among speakers is excessive. (No level correction is made.)	<ul style="list-style-type: none"> • Readjust the speaker installation so that all speakers are set in locations with similar conditions. • Check the speaker connections for proper polarity (+ / -). • Use speakers of similar quality and efficiency.

- If the ERROR or WARNING screens appears, check the cause of the problem, then perform the auto setup procedure again.
- If warning W-1 appears, corrections are made, but they may not be optimal.
- If warning W-2 or W-3 appears, no corrections are made.
- If error E-10 occurs repeatedly, please contact a qualified YAMAHA service center.

PLAYBACK

Basic operations

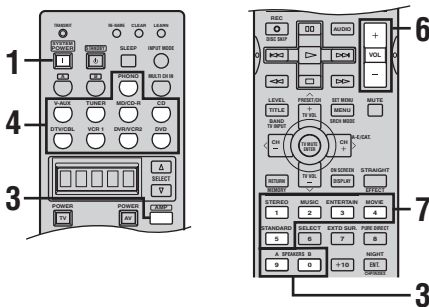
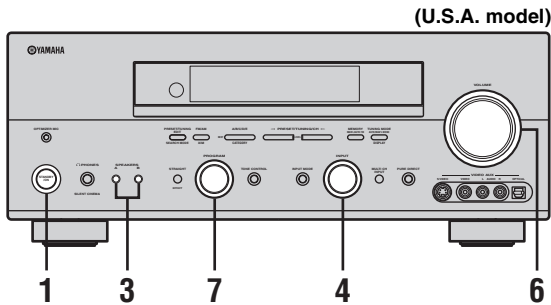

- 1 Press **STANDBY/ON** (or **SYSTEM POWER** on the remote control) to turn on the power.

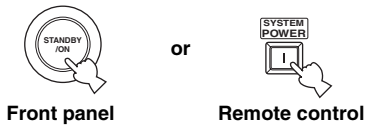

- 2 Turn on the video monitor connected to this unit.

- 3 Press **SPEAKERS A** or **B** (or press **AMP** to select the **AMP** mode, then press **SPEAKERS A** or **B** on the remote control).
Each press turns the respective speakers on or off.

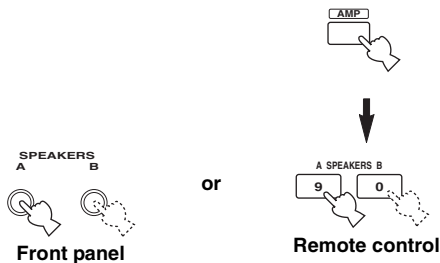

- 4 Select the input source.
Rotate **INPUT** (or press one of the input selector buttons on the remote control) to select the input you desire.

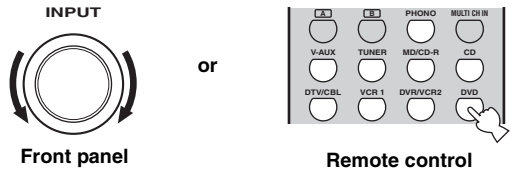

The current input source name and input mode appear in the front panel display and video monitor for a few seconds.

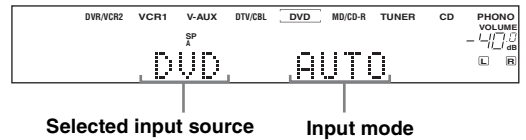

- 5 Start playback or select a broadcast station on the source component.
Refer to the operating instructions for the component.
- 6 Adjust the volume to the desired output level.

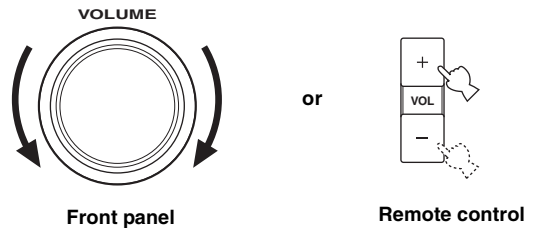

7 Select a sound field program if desired.

Use PROGRAM (or press AMP to select the AMP mode, then press one of the sound field program buttons) to select a sound field program. See page 56 for details about sound field programs.



or

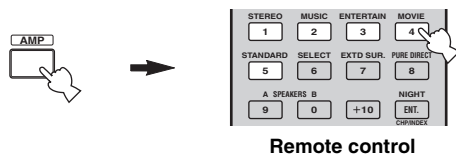

■ To listen with headphones (“SILENT CINEMA”)

“SILENT CINEMA” allows you to enjoy multi-channel music or movie sound, including Dolby Digital and DTS surround, through ordinary headphones. “SILENT CINEMA” activates automatically whenever you connect headphones to the PHONES jack while listening to CINEMA DSP or HiFi DSP sound field programs. When activated, the “SILENT CINEMA” indicator lights up in the front panel display.

Notes

- This unit will not be set to “SILENT CINEMA” when MULTI CH INPUT is selected as the input source.
- “SILENT CINEMA” is not effective when PURE DIRECT or the 2ch Stereo program is selected, or in STRAIGHT mode.

■ To adjust the tone

You can adjust the tonal quality of your front left and right, center, and subwoofer speakers or headphones (when connected). Press TONE CONTROL on the front panel repeatedly to select TREBLE or BASS, then rotate PROGRAM to the right or left to increase or decrease.

- Select TREBLE to adjust the high frequency response.
- Select BASS to adjust the low frequency response.



Speaker and headphone adjustments are stored independently.



Notes

- TONE CONTROL is not effective during playback in the PURE DIRECT mode, or when MULTI CH INPUT is selected (page 35).
- When TONE BYPASS is set to “AUTO” (page 68), and BASS and TREBLE are set to 0 dB, audio output automatically bypasses this unit's tone control circuitry.

■ To mute the sound

Press MUTE on the remote control. The MUTE indicator blinks in the front panel display. To resume the audio output, press MUTE again (or press VOL -/+). The MUTE indicator disappears from the display.



You can adjust the muting level (see page 68).



■ Selecting MULTI CH INPUT

Press MULTI CH INPUT (or MULTI CH IN on the remote control) so that “MULTI CH INPUT” appears in the front panel display and video monitor.

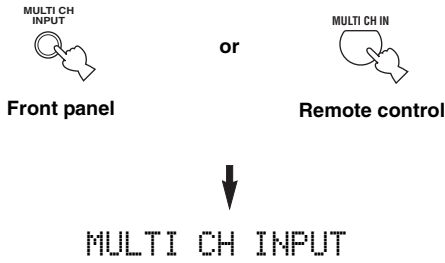

Note

When “MULTI CH INPUT” is shown in the front panel display, no other source can be played. To select another input source with INPUT (or one of the input selector buttons), press MULTI CH INPUT (or MULTI CH IN on the remote control) to turn off “MULTI CH INPUT” in the front panel display.

■ Playing video sources in the background

You can combine a video image from a video source with sound from an audio source. For example, you can enjoy listening to classical music while viewing beautiful scenery from the video source on the video monitor.

Use the input selector buttons on the remote control to select a video source, then select an audio source.

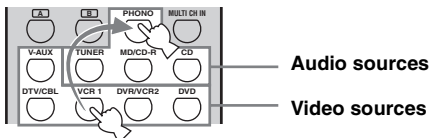

Note

If you want to enjoy audio from the MULTI CH INPUT jacks together with a video source, first select the video source, then press MULTI CH INPUT (or MULTI CH IN on the remote control).

Selecting sound field programs

■ Front panel operation

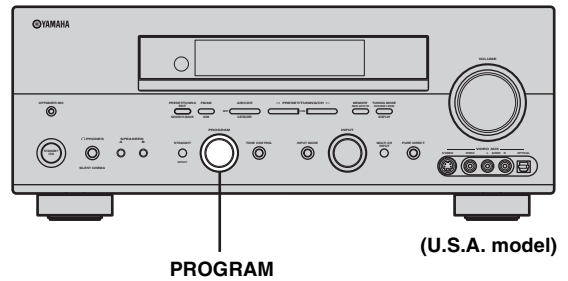

Rotate PROGRAM to select the desired program.
The name of the selected program appears in the front panel display and video monitor.

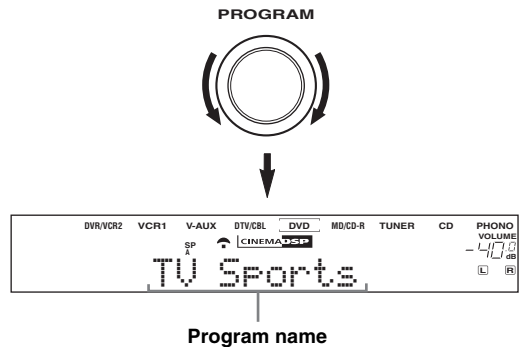

Remote control operation

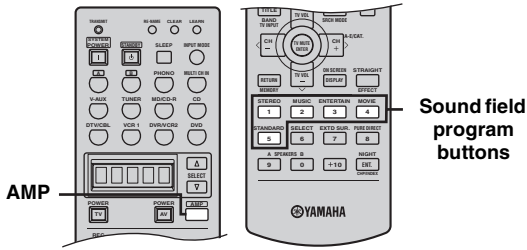

Press **AMP** to select the **AMP** mode, then press one of the sound field program buttons to select the desired program.

The name of the selected program appears in the front panel display.

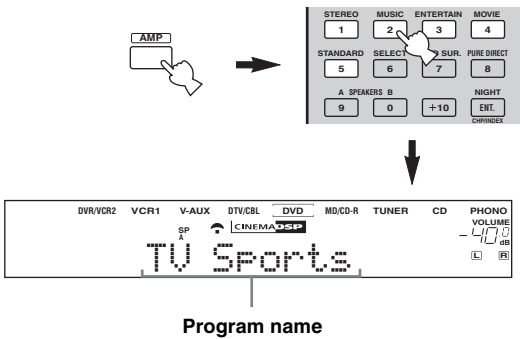

Choose a sound field program based on your listening preference, and not on the name of the program.

Notes

- When you select an input source, this unit automatically selects the last sound field program used with that source.
- Sound field programs cannot be selected when **MULTI CH INPUT** is selected.
- Sampling frequencies higher than 48 kHz (except for DTS 96/24 signals) will be sampled down to 48 kHz, then sound field programs will be applied.

Enjoying multi-channel software

If you connected a surround back speaker, use this feature to enjoy 6.1/7.1-channel playback for multi-channel sources using the Dolby Pro Logic IIX, Dolby Digital EX or DTS-ES decoders.

Press **AMP** to select the **AMP** mode, then press **EXTD SUR.** on the remote control to switch between 5.1 and 6.1/7.1-channel playback.



To select a decoder, press **</>** repeatedly when **PLIIXMusic (etc.)** is displayed.

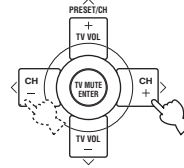

Auto (AUTO)

When a signal (flag) that can be recognized by the unit is input, the unit selects the optimum decoder for playing back the signal in 6.1/7.1 channels.

If the unit cannot recognize the flag or no flag is present in the input signal, it cannot automatically be played in 6.1/7.1 channels.

Decoders (select with </>)

You can select from the following decoders depending on the format of the software you are playing.

PLIIXMovie

For playing back Dolby Digital or DTS signals in 6.1/7.1 channels using the Pro Logic IIX movie decoder.

PLIIXMusic

For playing back Dolby Digital or DTS signals in 6.1/7.1 channels using the Pro Logic IIX music decoder.

EX/ES

For playing back Dolby Digital signals in 6.1/7.1 channels using the Dolby Digital EX decoder.

DTS signals are played back in 6.1/7.1 channels using the DTS-ES decoder.

EX

For playing back Dolby Digital or DTS signals in 6.1/7.1 channels using the Dolby Digital EX decoder.

Off (OFF)

Decoders are not used to create 6.1/7.1 channels.



When "SUR. B SP" is set to SMLx1 or LRGx1 (see page 65), the surround back channel will be output from the left SURROUND BACK speaker terminals.

Notes

- Some 6.1-channel compatible discs do not have a signal (flag) which this unit can automatically detect. When playing these kinds of discs with 6.1-channel, select a decoder (PLIIx Movie, PLIIx Music, EX/ES or EX) manually.
- 6.1-channel playback is not possible even if EXT D SUR. is pressed in the following cases:
 - When “SUR. L/R SP” (see page 64) or “SUR. B L/R SP” (see page 65) is set to NONE.
 - When the source connected to the MULTI CH INPUT jack is being played.
 - When the source being played does not contain surround left and right channel signals.
 - When a Dolby Digital KARAOKE source is being played.
 - When “2ch Stereo” or PURE DIRECT is selected.
- When the power of this unit is turned off, this setting will be reset to AUTO.
- The Pro Logic Iix decoder is not available when “SUR. B L/R SP” is set to NONE (see page 65).
- PLIIxMovie cannot be selected when “SUR. B L/R SP” is set to SMLx1 or LRGx1 (see page 65).

■ Enjoying 2-channel software in surround

Signals input from 2-channel sources can also be played back on multiple channels.

Press AMP to select the AMP mode, then press STANDARD on the remote control to switch between the SUR. STANDARD and SUR. ENHANCED programs.



Or press MOVIE to select the MOVIE THEATER program.



Press SELECT on the remote control to select the decoder.



You can select from the following modes depending on the type of software you are playing and your personal preference.

When you select the SUR. STANDARD program:

PRO LOGIC
Dolby Pro Logic processing for any sources.

PLII Movie
Dolby Pro Logic II processing for movie software.

PLII Music
Dolby Pro Logic II processing for music software.

PLII Game
Dolby Pro Logic II processing for game software.

PLIIx Movie
Dolby Pro Logic Iix processing for movie software.

PLIIx Music
Dolby Pro Logic Iix processing for music software.

PLIIx Game
Dolby Pro Logic Iix processing for game software.

Neo:6 Cinema
DTS processing for movie software.

Neo:6 Music
DTS processing for music software.

When you select the SUR. ENHANCED or MOVIE THEATER program:

PRO LOGIC
Dolby Pro Logic processing for any sources.

PLII Movie
Dolby Pro Logic II processing for movie software.

PLIIx Movie
Dolby Pro Logic Iix processing for movie software.

Neo:6 Cinema
DTS processing for movie software.



You can also select a decoder by pressing </> on the remote control when the decoder type is displayed in the short message display.

Note

The Pro Logic Iix decoder is not available when “SUR. B L/R SP” is set to NONE (see page 59).

■ Listening to high fidelity stereo sound (PURE DIRECT)

PURE DIRECT allows you to bypass this unit's decoders and DSP processors, and turn off the video circuitry and front panel display to enjoy pure high fidelity sound from analog and PCM sources.

Press PURE DIRECT (or press AMP to select the AMP mode, then press PURE DIRECT on the remote control) to activate pure direct.

The indicator around the front panel button lights up.

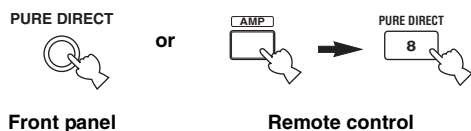

The front panel display switches on momentarily when an operation is performed.

To cancel, press PURE DIRECT again.

The indicator around the front panel button goes out and the previous settings are restored.

Notes

- To avoid unexpected noise, do not play DTS-encoded CDs in this mode.
- When a multi-channel signal (Dolby Digital or DTS) is input, this unit automatically switches to the corresponding analog input.
- No sound will be output from the subwoofer.
- The following operations are not possible during PURE DIRECT operation:
 - switching the sound field program
 - displaying the OSD
 - adjusting SET MENU parameters
 - all video functions (video conversion etc.)
- PURE DIRECT is automatically cancelled whenever this unit is set to the standby mode.

■ Night listening modes

The night listening modes are designed to improve listenability at lower volumes or at night. Choose either NIGHT:CINEMA or NIGHT:MUSIC depending on the type of material you are playing.

Press AMP to select the AMP mode, then press NIGHT repeatedly on the remote control to select cinema or music.

When night listening is selected, the NIGHT indicator in the front panel display lights up.



- Select NIGHT:CINEMA when watching films to reduce the dynamic range of film soundtracks and make dialog easier to hear at lower volumes.
- Select NIGHT:MUSIC when listening to music sources to preserve ease-of-listening for all sounds.
- Select OFF if you do not want to use this function.

Press </> to adjust the effect level while NIGHT:CINEMA or NIGHT:MUSIC is displayed.

This adjusts the level of compression.

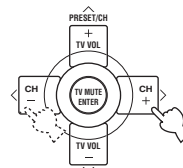

Remote control

Effect.Lvl: MID

- Select MIN for minimum compression.
- Select MID for standard compression.
- Select MAX for maximum compression.



NIGHT:CINEMA and NIGHT:MUSIC adjustments are stored independently.

Notes

- You cannot use the night listening modes with PURE DIRECT or MULTI CH INPUT (even though the NIGHT indicator lights up when PURE DIRECT is selected).
- The night listening modes may vary in effectiveness depending on the input source and surround sound settings you use.

■ Downmixing to 2 channels

You can enjoy 2-channel stereo playback even from multi-channel sources.

Rotate PROGRAM (or press AMP to select the AMP mode, then press STEREO on the remote control) to select 2ch Stereo.

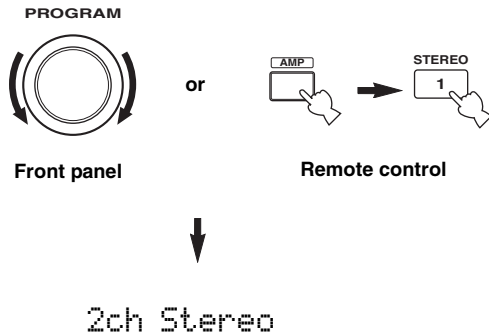

You can use a subwoofer with this program when SWFR or BOTH is selected in “BASS OUT”.

■ Listening to unprocessed input signals

In STRAIGHT mode, two channel stereo sources are output from only the front left and right speakers. Multi-channel sources are decoded straight into the appropriate channels without any additional effect processing.

Press STRAIGHT to select STRAIGHT.

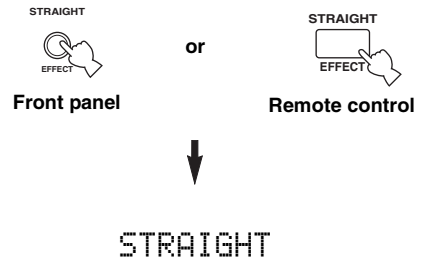

Press STRAIGHT (EFFECT) again so that “STRAIGHT” disappears from the display when you want to turn the sound effect back on.

■ Virtual CINEMA DSP

Virtual CINEMA DSP allows you to enjoy the CINEMA DSP programs without surround speakers. It creates virtual speakers to reproduce the natural sound field. If you set “SUR. L/R SP” to NONE (see page 64), Virtual CINEMA DSP activates automatically whenever you select a CINEMA DSP sound field program.

Note

Virtual CINEMA DSP will not activate, even when “SUR. L/R SP” is set to NONE (see page 64) in the following cases:

- When MULTI CH INPUT is selected as the input source.
- When headphones are connected to the PHONES jack.

Selecting input modes

This unit comes with a variety of input jacks. Do the following to select the type of input signals you want to use.

- 1 Rotate **INPUT** (or press one of the input selector buttons on the remote control) to select the input source.

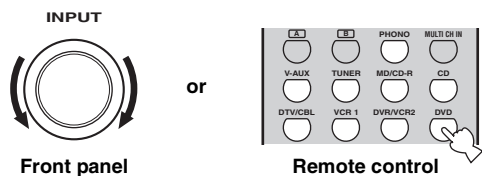

- 2 Press **INPUT MODE** to select an input mode. In most cases, use **AUTO**.

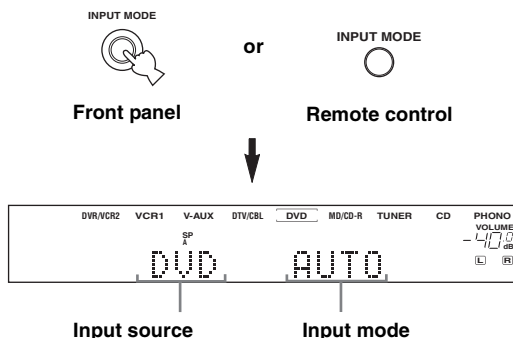

- AUTO** Automatically selects input signals in the following order:
- 1) Digital signals*
 - 2) Analog signals
- DTS** Selects only digital signals encoded in DTS. If no DTS signals are input, no sound is output.
- ANALOG** Selects only analog signals. If no analog signals are input, no sound is output.

* If this unit detects a Dolby Digital or DTS signal, the decoder automatically switches to the appropriate decoder.



You can adjust the default input mode of this unit (see page 70).

Notes

- When playing a DTS-CD/LD, be sure to set the INPUT MODE to DTS.
- If the digital output data of the player has been processed in any way, you may not be able to perform DTS decoding even if you make a digital connection between this unit and the player depending on the player.

■ Displaying information about the input source

You can display the type, format and sampling frequency of the current input signal.

- 1 Select the input source.

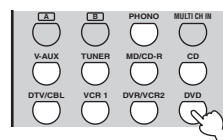

- 2 Press **STRAIGHT**.

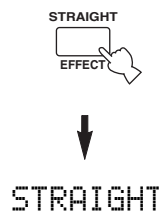

3 Press \wedge / \vee to display the following information about the input signal.

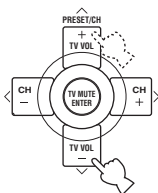

- (Format) Signal format display. When the unit cannot detect a digital signal it automatically switches to analog input.
- `in` Number of source channels in the input signal. For example, a multi-channel soundtrack with 3 front channels, 2 surround channels and LFE, is displayed as “3/2/LFE”.
- `fs` Sampling frequency. When the unit is unable to detect the sampling frequency “Unknown” appears.
- `rate` Bit rate. When the unit is unable to detect the bit rate “Unknown” appears.
- `flg` Flag data encoded with DTS or Dolby Digital signals that cue this unit to automatically switch decoders.

FM/AM TUNING

Automatic and manual tuning

There are 2 tuning methods; automatic and manual. Automatic tuning is effective when station signals are strong and there is no interference.

Automatic tuning

(U.S.A. model)

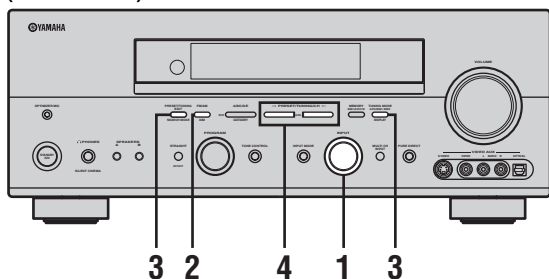

- 1 Rotate INPUT to select TUNER as the input source.

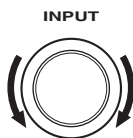

- 2 Press FM/AM to select the reception band. "FM" or "AM" appears in the front panel display.

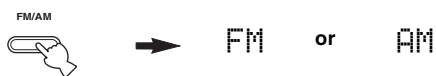

- 3 Press TUNING MODE (AUTO/MAN'L MONO) so that the AUTO indicator lights up in the front panel display.



If a colon (:) appears in the front panel display, tuning is not possible. Press PRESET/TUNING (EDIT) to turn the colon (:) off.

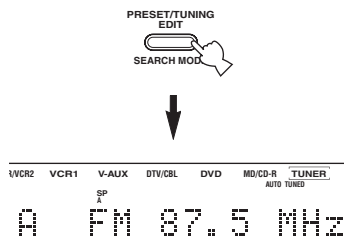

- 4 Press PRESET/TUNING/CH </> once to begin automatic tuning.

Press > to tune into a higher frequency, or press < to tune into a lower frequency.

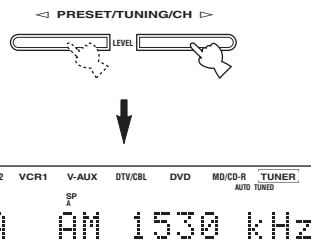

When tuned into a station, the TUNED indicator lights up and the frequency of the received station is shown in the front panel display.

Manual tuning

If the signal from the station you want to select is weak, tune into it manually. Manually tuning into an FM station will automatically switch the tuner to monaural reception to increase the signal quality.

1 Select TUNER and the reception band following steps 1 and 2 as described in “Automatic tuning”.

2 Press TUNING MODE (AUTO/MAN'L MONO) so that the AUTO indicator disappears from the front panel display.



If a colon (:) appears in the front panel display, tuning is not possible. Press PRESET/TUNING (EDIT) to turn the colon (:) off.

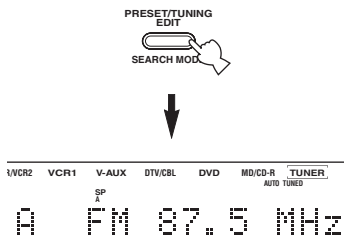

3 Press PRESET/TUNING/CH </> to tune into the desired station manually.

Hold down the button to continue searching.



Presetting stations

Automatically presetting FM stations

You can use the automatic preset tuning feature to store FM stations. This function enables this unit to automatically tune into FM stations with strong signals, and to store up to 40 (8 stations in 5 groups, A1 through E8) of those stations in order. You can then recall any preset station easily by selecting the preset station number.

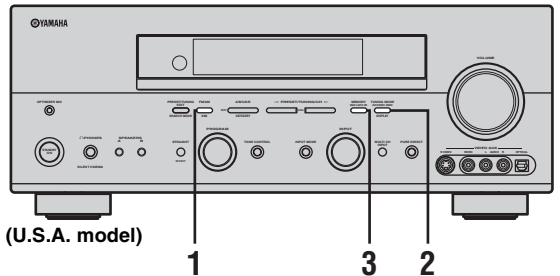

1 Press FM/AM to select the FM band.



2 Press TUNING MODE (AUTO/MAN'L MONO) so that the AUTO indicator lights up in the front panel display.



If a colon (:) appears in the front panel display, tuning is not possible. Press PRESET/TUNING (EDIT) to turn the colon (:) off.

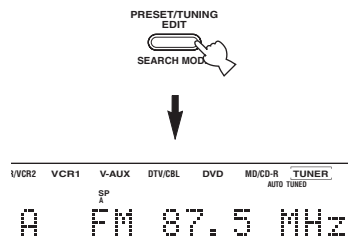

3 Press and hold MEMORY (MAN'L/AUTO FM) for more than 3 seconds.

The preset number, the MEMORY and AUTO indicators flash. After about 5 seconds, automatic presetting starts from the frequency currently displayed and proceeds toward the higher frequencies.

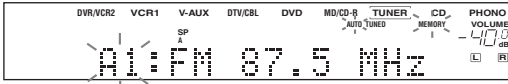
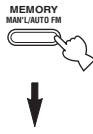

When automatic preset tuning is completed, the front panel display shows the frequency of the last preset station.

Notes

- Any stored station data existing under a preset number is cleared when you store a new station under that preset number.
- If the number of received stations does not reach 40 (E8), automatic preset tuning has automatically stopped after searching all stations.
- Only FM stations with sufficient signal strength are stored automatically by automatic preset tuning. If the station you want to store is weak in signal strength, tune into it manually, and store it by following the procedure in "Manually presetting stations".

Automatic preset tuning options:

You can select the preset number from which this unit will store FM stations and/or begin tuning toward lower frequencies.

After pressing MEMORY in step 3:

- 1 Press A/B/C/D/E, then PRESET/TUNING/CH < / > to select the preset number under which the first station will be stored. Automatic preset tuning will stop when stations have all been stored up to E8.
- 2 Press PRESET/TUNING (EDIT) to turn off the colon (:), and then press PRESET/TUNING/CH < to begin tuning toward the lower frequencies.

Memory back-up

The memory back-up circuit prevents the stored data from being lost even if this unit is set in the standby mode, the power cord is disconnected from the AC outlet, or the power supply is temporarily cut due to power failure. However, if the power is cut for more than one week, the preset stations may be cleared. If so, store the stations again by using the presetting station methods.

Manually presetting stations

You can also store up to 40 stations (8 stations in 5 groups, A1 through E8) manually.

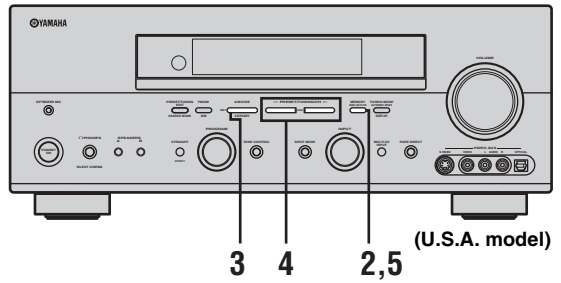

1 Tune into a station.

See page 39 for tuning instructions.

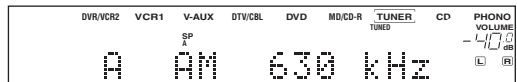

When tuned into a station, the front panel display shows the frequency of the station received.

2 Press MEMORY (MAN'L/AUTO FM).

The MEMORY indicator flashes for about 5 seconds.



3 Press A/B/C/D/E (NEXT) repeatedly to select a preset station group (A to E) while the MEMORY indicator is flashing.

The group letter appears. Check that the colon (:) appears in the front panel display.

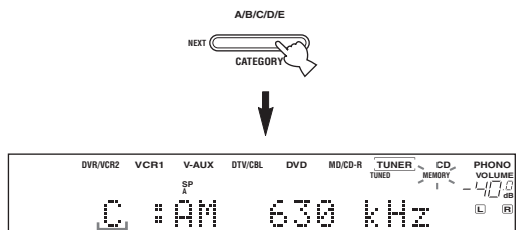

Preset group

- 4 Press PRESET/TUNING/CH </> to select a preset station number (1 to 8) while the MEMORY indicator is flashing.**

Press > to select a higher preset station number.
Press < to select a lower preset station number.

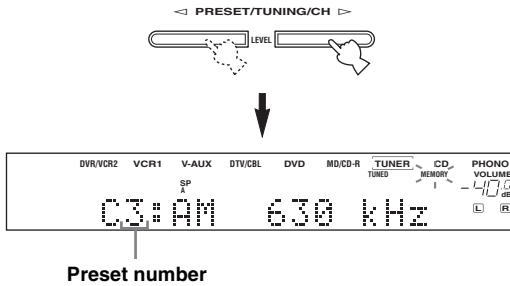

- 5 Press MEMORY (MAN'L/AUTO FM) on the front panel while the MEMORY indicator is flashing.**

The station band and frequency appear in the front panel display with the preset group and number you have selected.

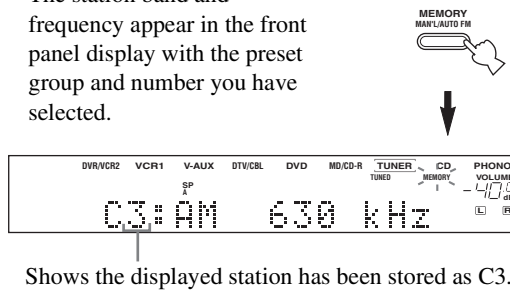

- 6 Repeat steps 1 to 5 to store other stations.**

Notes

- Any stored station data existing under a preset number is cleared when you store a new station under that preset number.
- The reception mode (stereo or monaural) is stored along with the station frequency.

Selecting preset stations

You can tune any desired station simply by selecting the preset station number under which it was stored.

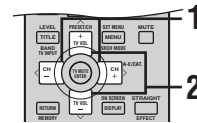
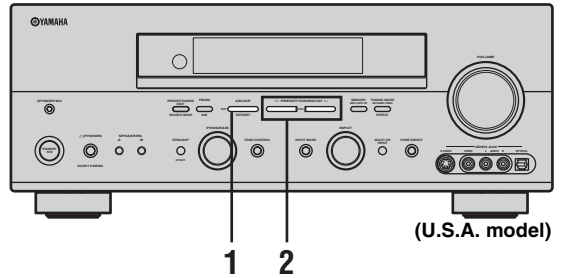

When performing this operation with the remote control, first press TUNER to set the remote to tuner mode.

- 1 Press A/B/C/D/E (NEXT) (or A-E/CAT. </>) on the remote control) to select the preset station group.**

The preset group letter appears in the front panel display and changes each time you press the button.

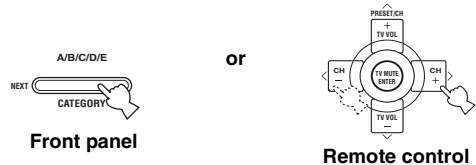

- 2 Press PRESET/TUNING/CH ◀/▶ (or PRESET ^/▼ on the remote control) to select a preset station number (1 to 8).**

The preset group and number appear on the front panel display along with the station band, frequency and the TUNED indicator lights up.

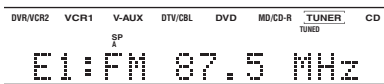
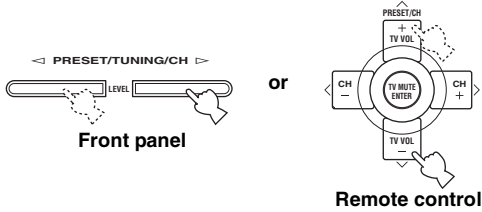

Exchanging preset stations

You can exchange the assignment of two preset stations with each other. The example below describes the procedure for exchanging preset station “E1” with “A5”.

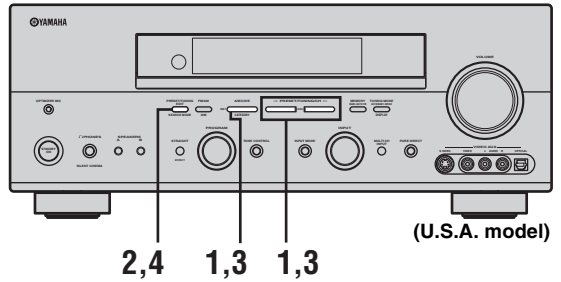

- 1 Select preset station “E1”.**
See “Selecting preset stations”.
- 2 Press and hold PRESET/TUNING (EDIT) for more than 3 seconds.**
“E1” and the MEMORY indicator flash in the front panel display.

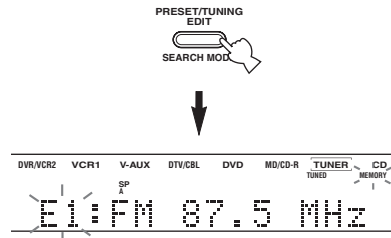

- 3 Select preset station “A5” using A/B/C/D/E and PRESET/TUNING/CH ◀/▶.**
“A5” and the MEMORY indicator flash in the front panel display.

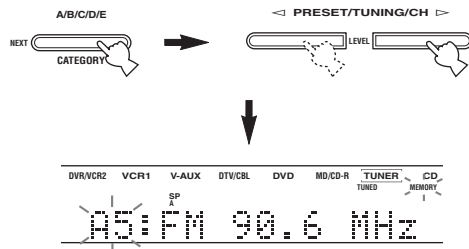

4 Press PRESET/TUNING (EDIT) again.

The stations stored at the two preset assignments are exchanged.

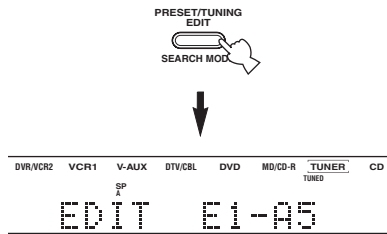

XM SATELLITE RADIO TUNING

What is XM Satellite Radio?

XM Satellite Radio is the satellite radio service with millions of listeners across the U.S. Broadcasting live daily. XM's channel lineup includes more than 130 digital channels of choice from coast to coast: 68 commercial-free music channels, featuring hip hop to opera, classical to country, bluegrass to blues; 33 channels of premier sports, talk, comedy, children's and entertainment programming; and more than 20 channels of the traffic and weather information for major metropolitan areas nationwide.

Because XM Satellite Radio is a subscription service, you will need to set up an account and activate service with XM using your XM Satellite Radio ID number. To check your ID number, follow "Activating XM Satellite Radio" on page 47. For further information on XM Satellite Radio services, see the XM Satellite Radio website at "<http://www.xmradio.com>".

Notes

- The XM Satellite Radio service is only available in the 48 contiguous United States (not available in Alaska and Hawaii).
- XM connect and Play digital antenna accessory and monthly subscription are sold separately. For details, see the XM Satellite Radio website at "<http://www.xmradio.com>".

XM Satellite Radio connections

■ Connecting the XM connect and Play digital antenna accessory

Connect the XM connect and Play digital antenna accessory (sold separately) to the XM jack on the rear of this unit. (For details, see the operating instructions provided with the XM connect and Play digital antenna accessory).

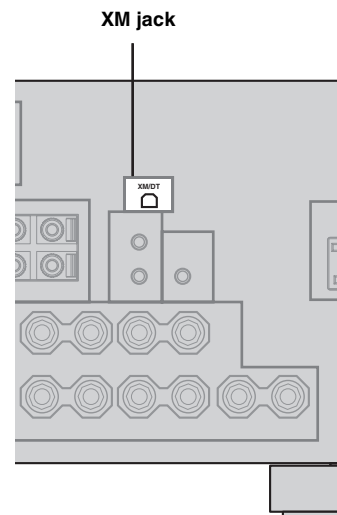

Notes

- For information on obtaining the XM connect and Play digital antenna accessory, see the website at "<http://www.xmradio.com>" or visit your local retailer that sells XM Ready products.
- To ensure optimal reception of XM's satellite signal, the XM connect and Play digital antenna accessory should be placed at or near a southerly facing window with nothing obstructing its path to the sky. You can mount it indoors or outdoors.

XM Satellite Radio functions

This section describes the functions of each control used for XM Satellite Radio tuning.

Front panel functions

Note

The following controls are only available when the unit is in the TUNER mode and the XM connect and Play digital antenna accessory is connected to the XM jack on the rear of this unit (For details, see “XM Satellite Radio connections”).

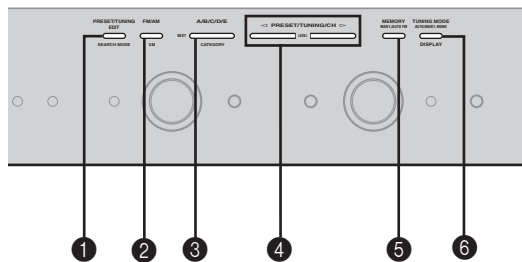

1 SEARCH MODE

Switches between the All Channel Search, Category Search, and Preset Search modes. (For details, see “XM Satellite Radio search modes” on page 49)

2 XM

Switches the reception band between AM, FM and XM.

3 CATEGORY

(All Channel Search mode)

Changes the channel category to next one (while staying in the All Channel Search mode).

(Category Search mode)

Changes the channel category to next one.

(Preset Search mode)

Switches between five preset groups (A to E).

4 PRESET/TUNING/CH </>

(All Channel Search mode)

Searches a radio channel within all channels. Press and hold for quick search.

(Category Search mode)

Searches a radio channel within the selected category. Press and hold for quick search.

(Preset Search mode)

Changes the preset number (1 to 8).

5 MEMORY

Switches the unit to the preset memory mode.

6 DISPLAY

Switches XM information such as channel number/name, category, or artist name/song title displayed in the front panel display and on-screen display. (For details, see “Switching XM information in the front panel display” on page 48).

Remote control functions

Note

The following controls are only available when the unit is in the TUNER mode. To switch to the TUNER mode, press TUNER to select TUNER as input source.

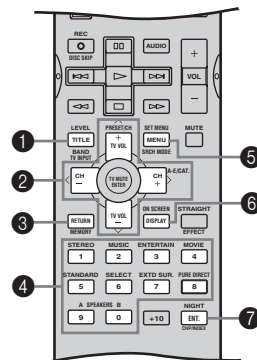

1 BAND

Switches the reception band between the currently selected band (AM or FM) and XM.

2 Cursor buttons ^ / v / < / >

(All Channel Search mode)

Press A-E/CAT. </> to change the channel category.

Press PRESET/CH ^ / v to search a radio channel within all channels. Press and hold for quick search.

(Category Search mode)

Press A-E/CAT. </> to change the channel category.

Press PRESET/CH ^ / v to search a radio channel within the selected category. Press and hold for quick search.

(Preset Search mode)

Press A-E/CAT. </> to change the preset group (A to E).

Press PRESET/CH ^ / v to change the preset number (1 to 8).

3 MEMORY

Switches the unit to the preset memory mode.

4 Numeric buttons

(All Channel Search or Category Search mode)

Use 1 to 9 and 0 to enter a channel number directly.

(Preset Search mode)

Use 1 to 8 to enter a preset channel number directly.

5 SRCH MODE

Switches between the All Channel Search, Category Search, and Preset Search modes. (For details, see “XM Satellite Radio search modes” on page 49)

6 DISPLAY

Switches XM information such as channel number/name, category, or artist name/song title displayed in the front panel display and on-screen display. (For details, see “Switching XM information in the front panel display” on page 48).

7 ENT.

Confirms an entered channel number during the Direct Number Access mode (see page 51).

Activating XM Satellite Radio

To sign up for an account with the XM Satellite Radio service, an XM Satellite Radio ID number is required. Follow the procedure below to check your ID number, and then access the website at “http://activate.xmradio.com” or call “1-800-XM-RADIO (1-800-967-2346)” with a major credit card for signing up.

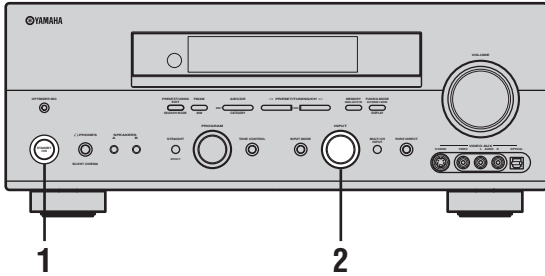

- 1 Rotate INPUT (or press TUNER on the remote control) to select TUNER as the input source.

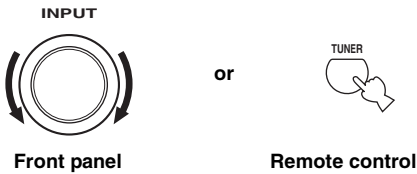

- 2 Press XM (or BAND on the remote control) to select “XM” as the reception band.

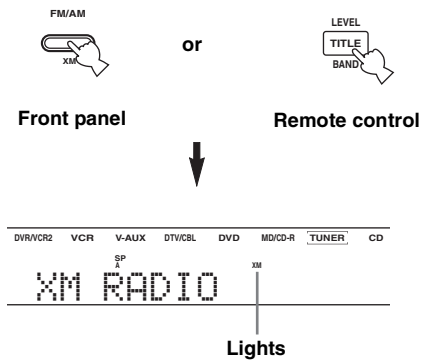

If “CHECK ANTENNA” appears in the front panel display, the XM connect and Play digital antenna accessory may not be connected to the XM jack on the rear of this unit properly. See “XM Satellite Radio connections” on page 45 and check the connection.

- 3 Press PRESET/TUNING/CH ◀/▶ (or PRESET/CH ^/∨ on the remote control) to select channel “0”.

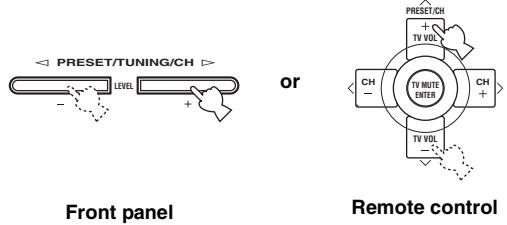

Note

You cannot select channel “0” if the All Channel Search mode (see page 49) is not selected.

- 4 Check the XM Satellite Radio ID number displayed in the front panel display and write it down.

ID: _____

Basic XM Satellite Radio operations

■ Selecting the XM Satellite Radio mode

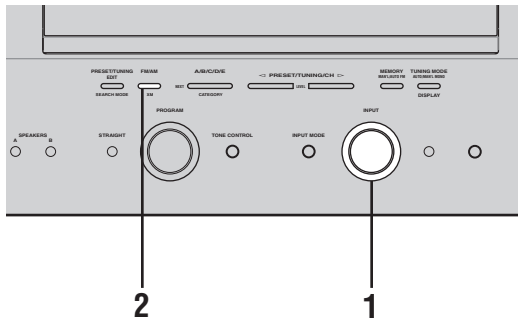

1 Rotate INPUT (or press TUNER on the remote control) to select TUNER as the input source.

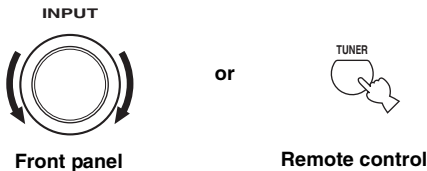

2 Press XM (or BAND on the remote control) to select “XM” as the reception band.

Information (such as channel number/name, category, or artist name/song title) for the channel currently selected appears in the front panel display and the XM indicator lights up.

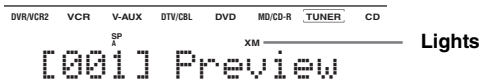
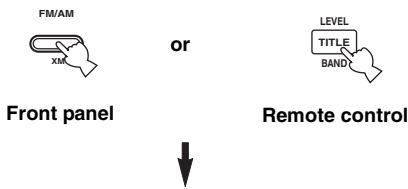

- Selecting the “XM” band automatically recalls the channel previously selected.
- You can change the kind of XM information by pressing DISPLAY repeatedly. (For details, see “Switching XM information in the front panel display” on page 48).

Note

XM Satellite Radio signals cannot be output from the AUDIO OUT (REC) jacks.

■ Switching XM information in the front panel display

You can display XM information (such as channel number/name, category, or artist name/song title) for the channel currently selected in the front panel display.

Press DISPLAY on the unit (or remote control during the TUNER mode) repeatedly to toggle between the following channel information display modes.

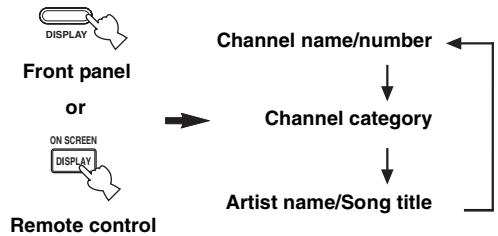

When the channel number/name is displayed:



When the channel category is displayed:



When the artist name/song title is displayed:



- The front panel display can indicate up to 14 alphanumeric characters at once. If the information contains more than 14 characters, the information scrolls from right to left.
- If the information contains a character that cannot be recognized by the unit, the character will be displayed with an underbar “_”.

Note

If a status message or an error message appears in the display, see “Status and error messages” on page 54.

■ Displaying XM information in the on-screen display

You can display XM information on a video monitor by pressing DISPLAY. It is much easier to see the available information than reading it on the front panel display.

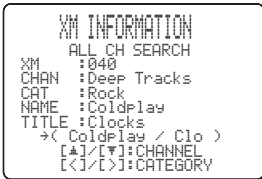

- In the SET MENU (see page 73), you can set the time for displaying XM information in the on-screen display.
- When “XM DISPLAY” in the SET MENU is set to “OFF”, you cannot display XM information in the on-screen display.
- If the information contains a character that cannot be recognized by the unit (on-screen display program), the character will be displayed with an underbar “_”.

XM Satellite Radio search modes

You can search for the channel you want to listen to using one of three search modes. You can also enter the number directly to select the desired channel (For details, see “Direct Number Access mode” on page 51).

■ All Channel Search mode

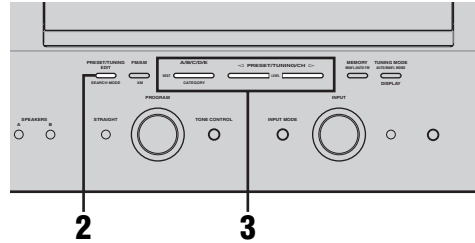

1 Carry out “Selecting the XM Satellite Radio mode” on page 48.

2 Press SEARCH MODE (or SRCH MODE on the remote control) repeatedly to select “ALL CH SEARCH”.

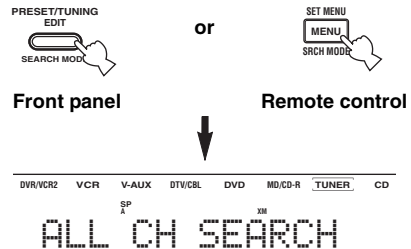

- 3** To change the channel category, press **CATEGORY** (or **A-E/CAT. </>** on the remote control) repeatedly.

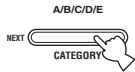

Front panel

or

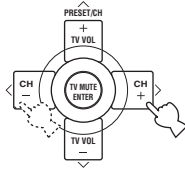

Remote control

To search a channel within all channels, press **PRESET/TUNING/CH </>** (or **PRESET/CH ^ / v** on the remote control) repeatedly.



Front panel

or

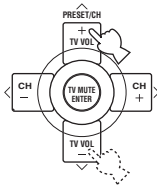

Remote control



You can search a channel with the quick search by pressing and holding **PRESET/TUNING/CH </>** (or **PRESET/CH ^ / v** on the remote control).

Category Search mode

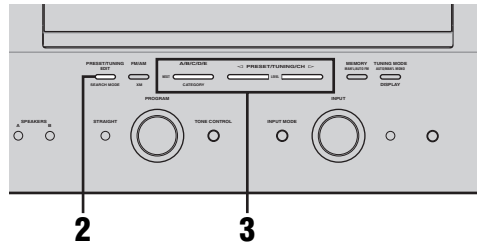

- 1** Carry out "Selecting the XM Satellite Radio mode" on page 48.

- 2** Press **SEARCH MODE** (or **SRCH MODE** on the remote control) repeatedly to select "CAT SEARCH".



Front panel

or



Remote control



- 3** To change the channel category, press **CATEGORY** (or **A-E/CAT. </>** on the remote control) repeatedly.

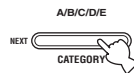

Front panel

or

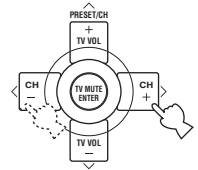

Remote control

To search a channel within the selected channel category, press **PRESET/TUNING/CH </>** (or **PRESET/CH ^ / v** on the remote control) repeatedly.



Front panel

or

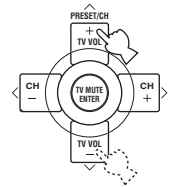

Remote control



You can search a channel with the quick search by pressing and holding **PRESET/TUNING/CH </>** (or **PRESET/CH ^ / v** on the remote control).

■ Preset Search mode

Prior to selecting a preset channel in the Preset Search mode, you should preset XM Satellite Radio channels. For details, see “Setting XM Satellite Radio preset channels” on page 52. All preset channels (A1 to E8) recalls “001 Preview” by the factory setting.

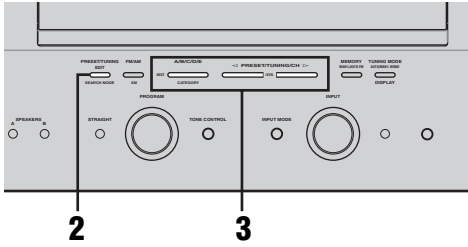

1 Carry out “Selecting the XM Satellite Radio mode” on page 48.

2 Press SEARCH MODE (or SRCH MODE on the remote control) repeatedly to select “PRESET SEARCH”.

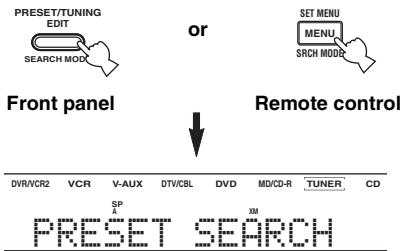

3 To change the preset group (A to E), press CATEGORY (or A-E/CAT. </> on the remote control) repeatedly.

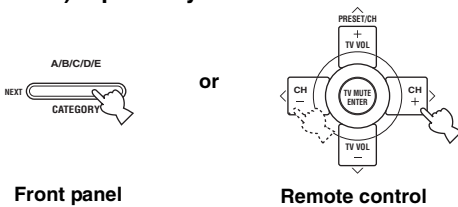

To change the preset number (1 to 8), press PRESET/TUNING/CH </> (or PRESET/CH ^ / v on the remote control) repeatedly.

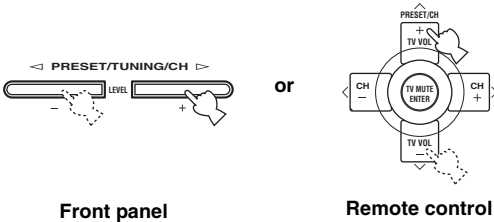

■ Direct Number Access mode

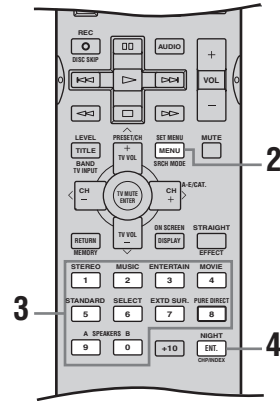

1 Carry out “Selecting the XM Satellite Radio mode” on page 48.

2 Press SEARCH MODE (or SRCH MODE on the remote control) repeatedly to select “ALL CH SEARCH” or “CAT SEARCH”.

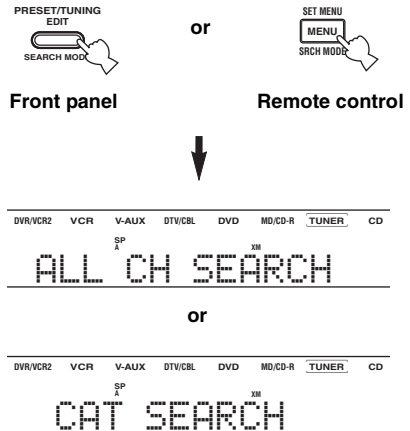

BASIC OPERATION



You can also select the preset number directly by pressing the numeric buttons (1 to 8) on the remote control.

3 Press the numeric buttons to enter the desired channel number.

For example, to enter the number 123, press the numeric buttons as shown below.



The display changes as follows.

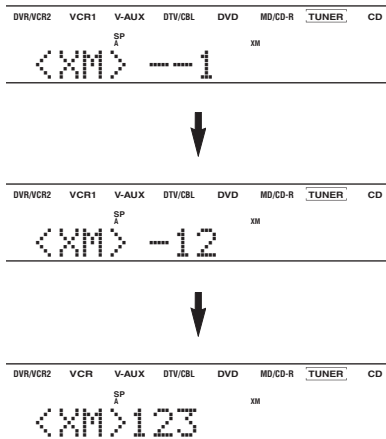

4 If you enter fewer than three numbers you may press ENT. to tune to the channel immediately or wait a few seconds to confirm the entered channel number.



- If no button is pressed within a few seconds after entering one-digit or two-digit number, the unit automatically confirms the entered channel number.
- Pressing a button other than numeric buttons or ENT. cancels the direct number access procedure.

Setting XM Satellite Radio preset channels

You can use this feature to store up to 40 XM Satellite Radio channels (eight preset numbers in five preset groups, A1 to E8). You can then recall any preset channel easily by selecting the preset group and number as described in “Preset Search mode” on page 51.

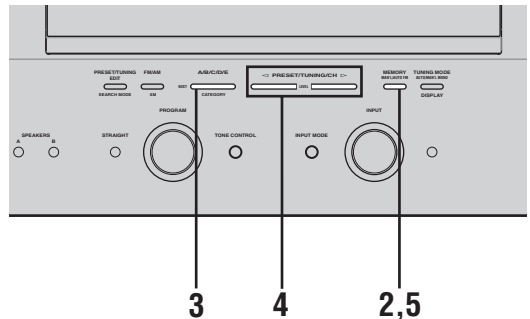

1 Search the XM Satellite Radio channel you want to set as a preset channel.

To search the desired channel, carry out “All Channel Search mode” or “Category Search mode” on page 46, or “Direct Number Access mode” on page 51.



When the channel number “040” is selected

2 Press MEMORY on the unit (or remote control during the TUNER mode).

The MEMORY indicator flashes for about five seconds.

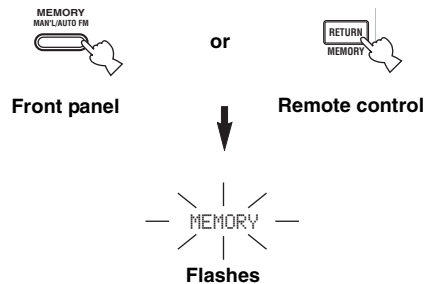

- 3** While the MEMORY indicator is flashing, press **CATEGORY** (or A-E/CAT. </> on the remote control) to select a preset group (A to E).
The group letter appears.

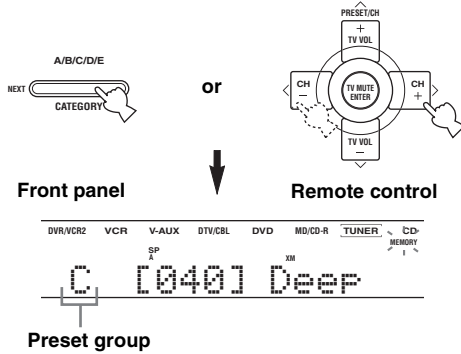

- 4** While the MEMORY indicator is flashing, press **PRESET/TUNING/CH** </> (or **PRESET/CH** ^ / v on the remote control) to select a preset number (1 to 8).

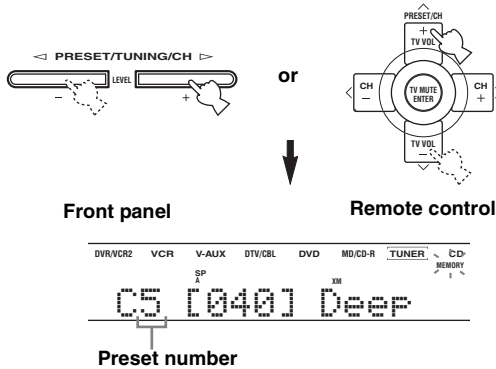

- 5** While the MEMORY indicator is flashing, press **MEMORY** on the unit (or the remote control) to preset the selected XM Satellite Radio channel.
A colon appears next to the preset number for confirmation, and the MEMORY indicator turns off.

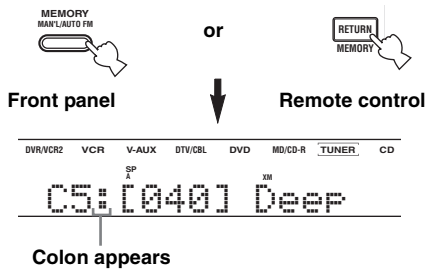

Note

Presetting a new channel clears the former preset channel stored in the same preset group and number.

■ Status and error messages

If an operation takes longer than usual or an error occurs, one of the following messages may appear in the front panel display. In this case, read the cause and follow the corresponding remedies.

Message	Cause	Remedy
CHECK ANTENNA	The XM connect and Play digital antenna accessory is not connected, or does not work properly.	<ul style="list-style-type: none"> • Check the XM connect and Play digital antenna accessory connections.
UPDATING	The XM user encryption code is being updated.	<ul style="list-style-type: none"> • Wait until the encryption code is updated.
NO SIGNAL	The signal is too weak.	<ul style="list-style-type: none"> • Check the XM connect and Play digital antenna accessory connections and orient it for the best reception.
LOADING	It takes longer than four seconds for audio or text data to be decoded.	<ul style="list-style-type: none"> • Wait until the decoding process has finished.
OFF AIR	The XM Satellite Radio channel you selected is not currently broadcasting any signal.	<ul style="list-style-type: none"> • Check the channel number again or select another XM Satellite Radio channel.
<XM> - - -	The channel station ID (SID) is no longer available.	
- - - / - - -	No artist name/feature or song/program title is available.	
<CAT> - - -	No channels are available for the selected category.	<ul style="list-style-type: none"> • Select another channel category by pressing CATEGORY (or A-E/CAT: </> on the remote control) repeatedly.

RECORDING

Recording adjustments and other operations are performed from the recording components. Refer to the operating instructions for those components.

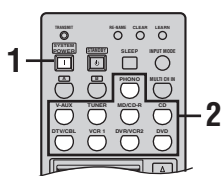
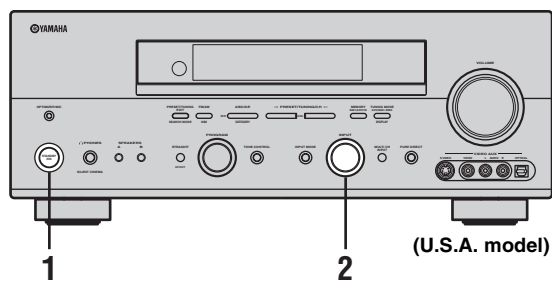

1 Turn on the power of this unit and all connected components.

2 Select the source component you want to record from.

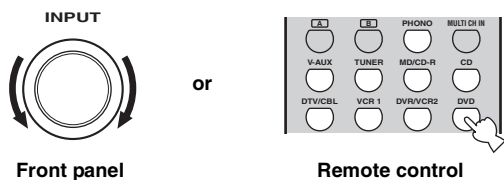

3 Start playback (or select a broadcast station) on the source component.

4 Start recording on the recording component.



Do a test recording before you start an actual recording.

Notes

- When this unit is set in the standby mode, you cannot record between other components connected to this unit.
- The setting of TONE CONTROL, VOLUME, “SPEAKER LEVEL” (page 66) and programs does not affect recorded material.
- A source connected to the MULTI CH INPUT jacks of this unit cannot be recorded.
- S-video and composite video signals pass independently through this unit’s video circuits. Therefore, when recording or dubbing video signals, if your video source component is connected to provide only an S-video (or only a composite video) signal, you can record only an S-video (or only a composite video) signal to your VCR.
- Digital signals input to the DIGITAL INPUT jacks are not output to the analog AUDIO OUT (L/R) jacks for recording. Likewise, analog signals input to the AUDIO IN (L/R) jacks are not output to the DIGITAL OUTPUT jack. Therefore, if your source component is connected to provide only digital (or analog) signals, you can only record digital (or analog) signals.
- A given input source is not output on the same REC OUT channel. (For example, the signal input from VCR 1 IN is not output on VCR 1 OUT.)
- Check the copyright laws in your country to record from records, CDs, radio, etc. Recording of copyrighted material may infringe copyright laws.

If you playback a video source that uses scrambled or encoded signals to prevent it from being dubbed, the picture itself may be disturbed due to those signals.

Special considerations when recording DTS software

The DTS signal is a digital bitstream. Attempting to digitally record the DTS bitstream will result in noise being recorded. Therefore, if you want to use this unit to record sources that have DTS signals recorded on them, the following considerations and adjustments need to be made.

For DVDs and CDs encoded with DTS, when your player is compatible with the DTS format, follow its operating instructions to make a setting so that the analog signal will be output from the player.

SOUND FIELD PROGRAM DESCRIPTIONS

This unit is equipped with a variety of precise digital decoders that allow you to enjoy multi-channel playback from almost any sound source (stereo or multi-channel). This unit is also equipped with a YAMAHA digital sound field processing (DSP) chip containing several sound field programs which you can use to enhance your playback experience. Most of these sound field programs are precise digital recreations of actual acoustic environments found in famous concert halls, music venues, and movie theaters.



The YAMAHA CINEMA DSP modes are compatible with all Dolby Digital, DTS, and Dolby Surround sources. Set the input mode to AUTO (see page 37) to enable this unit to automatically switch to the appropriate digital decoder according to the input signal.

Notes

- This unit's DSP sound field programs are recreations of real-world acoustic environments made from precise measurements taken in the actual hall, etc. Thus you may notice variations in the strength of the reflections coming from the front, back, left and right.
- Feel free to choose a sound field program based on your listening preference, and not purely on the name of the program itself.

For movie/video sources

You can select from the following sound fields when playing movie or video sources. The sound fields marked "MULTI" can be used with multi-channel sources, like DVD, digital TV, etc. Those marked "2-CH" can be used with 2-channel (stereo) sources like TV programs, video tapes, etc. 1

Program selection methods vary depending on sound field program types. For details on how to select sound field programs, see "Selecting sound field programs" on page 32 to 36.

Remote control button	Program	Features	Sources
1	STEREO: 2ch Stereo	Downmixes multi-channel sources to 2 channel (left and right) or plays back 2-channel sources as is.	
2	MUSIC: POP/ROCK	This program lends an enthusiastic atmosphere to the sound, giving you the feeling you are at an actual jazz or rock concert.	
3	ENTERTAINMENT: TV Sports	Though the presence sound field is relatively narrow, the surround sound field employs the sound environment of a large concert hall. This effect enhances the experience of watching various TV programs such as news, variety shows, music programs or sports programs.	MULTI 2-CH
	ENTERTAINMENT: Mono Movie	This program is provided for reproducing monaural video sources (such as old movies). The program produces the optimum reverberation to create sound depth using only the presence sound field.	
	ENTERTAINMENT: Game	This program adds a deep and spatial feeling to video game sounds.	
4	MOVIE THEATER: Spectacle	CINEMA DSP processing. This program creates the extremely wide sound field of a 70-mm movie theater. It precisely reproduces the source sound in detail, making both the video and the sound field incredibly real. This is ideal for any kind of video source encoded with Dolby Surround, Dolby Digital or DTS (especially large-scale movie productions).	
	MOVIE THEATER: Sci-Fi	CINEMA DSP processing. This program clearly reproduces dialog and sound effects in the latest sound form for science fiction films, thus creating a broad and expansive cinematic space amid silence. You can enjoy science fiction films in a virtual-space sound field that includes Dolby Surround, Dolby Digital and DTS-encoded software employing the most advanced techniques.	
	MOVIE THEATER: Adventure	CINEMA DSP processing. This program is ideal for precisely reproducing the sound design of the newest 70-mm and multi-channel soundtrack films. The sound field is made to be similar to that of the newest movie theaters, so the reverberations of the sound field itself are restrained as much as possible.	
	MOVIE THEATER: General	CINEMA DSP processing. This program is for reproducing sounds from 70-mm and multi-channel soundtrack films, and is characterized by soft and extensive sound field.	

Remote control button	Program	Features	Sources
5	SUR. STANDARD	Standard processing for the selected decoder.	MULTI 2-CH
	SUR. ENHANCED	Enhanced processing for the selected decoder.	

For music sources

You can select from the following sound fields when playing music sources, like CD, FM/AM broadcasting, tapes, etc.

Program selection methods vary depending on sound field program types. For details on how to select sound field programs, see “Selecting sound field programs” on page 32 to 36.

Remote control button	Program	Features	Sources
1	STEREO: 2ch Stereo	2-channel (left and right) playback.	2-CH
	STEREO: 7ch Stereo	Use to increase the output stereo sources (in stereo) from all speakers. This provides a larger sound field and is ideal for background music at parties, etc.	
2	MUSIC: Hall in Vienna	HiFi DSP processing. A classic shoe-box type concert hall with approximately 1700 seats. Pillars and ornate carvings create extremely complex reflections which produce a very full, rich sound.	MULTI 2-CH
	MUSIC: The Bttm Line	HiFi DSP processing. This is the sound field at stage front in “The Bottom Line”, a famous New York jazz club. The floor can seat 300 people to the left and right in a sound field offering a real and vibrant sound.	
	MUSIC: The Roxy Thtr	HiFi DSP processing. The ideal program for lively, dynamic rock music. The data for this program was recorded at LA’s “hottest” rock club. The listener’s virtual seat is at the center-left of the hall.	
3	ENTERTAINMENT: Disco	HiFi DSP processing. This program recreates the acoustic environment of a lively disco in the heart of a big city. The sound is dense and highly concentrated. It is also characterized by high-energy, “immediate” sound.	
5	SUR. STANDARD	Standard processing for the selected decoder.	MULTI 2-CH
	SUR. ENHANCED	Enhanced processing for the selected decoder.	

ADVANCED OPERATIONS

Selecting the OSD mode

You can display this unit's operating information on a video monitor. If you display the SET MENU and sound field program parameter settings on a monitor, it is much easier to see the available options and parameters than it is by reading this information on the front panel display.

1 Turn on the video monitor connected to this unit.

2 Press ON SCREEN repeatedly to change the OSD mode.

The OSD mode changes in the following order: full display, short display, and display off.



Full display

Always shows the sound field program parameter settings as well as the contents of the front panel display.

Short display

Briefly shows the contents of the front panel display at the bottom of the screen each time you operate this unit.

Display off

Only operations performed using ON SCREEN are displayed. The OSD is displayed when using SET MENU, even if the OSD mode is set to "Display off".

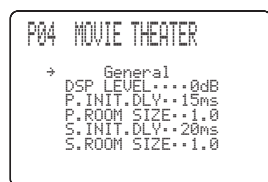

Full display

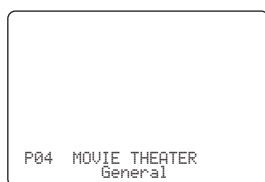

Short display

Notes

- The OSD signal is not output to the REC OUT jack, and will not be recorded.
- You can set the OSD to turn on (gray background) or off when a video source is not being reproduced (or the source component is turned off) by using "DISPLAY SET" (see page 71).
- When using component video signals, the "Short display" is not output to the COMPONENT VIDEO MONITOR OUT jacks. To display the OSD with component video signal input, set the OSD mode to "Full Display" while GRAY BACK in DISPLAY SET (see page 71) is set to AUTO.

Using the sleep timer

Use this feature to automatically set this unit in the standby mode after a certain amount of time. The sleep timer is useful when you are going to sleep while this unit is playing or recording a source. The sleep timer also automatically turns off any external components connected to AC OUTLET(S).

Setting the sleep timer

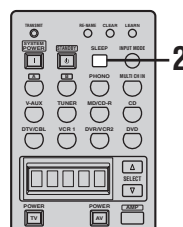

1 Select a source and start playback on the source component.

2 Press SLEEP repeatedly to set the amount of time.

Each time you press SLEEP, the front panel display changes as shown below. The SLEEP indicator flashes while switching the amount of time for the sleep timer.

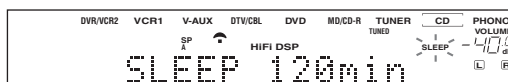
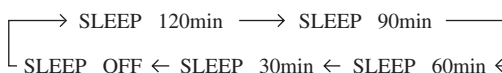

The SLEEP indicator lights up in the front panel display, and the display returns to the selected sound field program.

SLEEP indicator



■ Canceling the sleep timer

Press SLEEP repeatedly until “SLEEP OFF” appears in the front panel display.

After a few seconds, “SLEEP OFF” disappears, and the SLEEP indicator goes off.



The sleep timer setting can also be canceled by pressing STANDBY on the remote control (or STANDBY/ON on the front panel) to set this unit to the standby mode.

Manually adjusting speaker levels

You can adjust the output level of each speaker while listening to a music source. This is also possible when playing sources through the MULTI CH INPUT jacks. Please note that this operation will override the level adjustments made in “AUTO SETUP” (page 24), “SPEAKER LEVEL” (page 66).

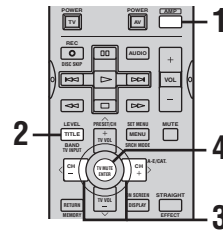

1 Press AMP.

2 Press LEVEL repeatedly to select the speaker you want to adjust.

- FRONT L Front left speaker level
- CENTER Center speaker level
- FRONT R Front right speaker level
- SUR. R Surround right speaker level
- SUR. L Surround left speaker level
- SUR. B. R Surround back right speaker level
- SUR. B. L Surround back left speaker level
- SWFR Subwoofer level
- PRES. L Presence left speaker level
- PRES. R Presence right speaker level



Once you press LEVEL, you can also select the speaker by pressing \wedge / \vee .

3 Press </> to adjust the speaker output level.
The control range is from +10 dB to -10 dB.

4 Press ENTER when you have completed your adjustment.



This operation can also be performed using the controls on the front panel. Press NEXT repeatedly to select the speaker you want to adjust, then press LEVEL $-/+$ to adjust the output level.

SET MENU

You can use the following parameters in SET MENU to adjust a variety of system settings and customize the way this unit operates. Change the initial settings (indicated in bold under each parameter) to reflect the needs of your listening environment.

■ AUTO SETUP

Use to specify which speaker parameters auto setup will adjust, and to activate the auto setup procedure (see page 24).

■ MANUAL SETUP

Use to manually adjust speaker and system parameters.

1 SOUND MENU

Use to manually adjust any speaker setting, alter the quality and tone of the sound output by the system or compensate for video signal processing delays when using LCD monitors or projectors.



Most of the parameters described in SOUND MENU are set automatically when you run auto setup (see page 24). You can use SOUND MENU to make further adjustments, but we recommend running auto setup first.

Item	Features	Page
A)SPEAKER SET	Selects the size of each speaker, the speakers for low-frequency signal output, and the cross over frequency.	64
B)SPEAKER LEVEL	Adjusts the output level of each speaker.	66
C)SP DISTANCE	Adjusts the delay time of each speaker.	67
D)EQUALIZER	Adjusts the tonal quality of the center speaker.	67
E)LFE LEVEL	Adjusts the output level of the LFE channel for Dolby Digital or DTS signals.	68
F)DYNAMIC RANGE	Adjusts the dynamic range for Dolby Digital or DTS signals.	68
G)AUDIO SET	Customizes the muting level, audio delay and tone bypass settings.	68

2 INPUT MENU

Use to reassign digital input/outputs, select the input mode or rename your inputs.

Item	Features	Page
A)I/O ASSIGNMENT	Assigns jacks according to the component to be used.	69
B)INPUT MODE	Selects the initial input mode of the source.	70
C)INPUT RENAME	Changes the name of the inputs.	70
D)VOLUME TRIM	Adjusts the output volume of each jack.	70

3 OPTION MENU

Use to adjust the optional system parameters.

Item	Features	Page
A)DISPLAY SET	Adjusts the brightness of the display and converts video signals.	71
B)MEMORY GUARD	Locks sound field program parameters and other SET MENU settings.	71
C)PARAM. INI	Initializes the parameters of a group of sound field programs.	72
D)MULTI ZONE SET	Specifies the location of the speakers connected to the SPEAKERS B terminals or selects how the ZONE 2 speakers will be amplified.	72
E)XM RADIO SET	Displays the current reception level for the XM connect and Play digital antenna accessory.	72

■ SIGNAL INFO

Use to check audio Signal information (see page 37).

Using SET MENU

Use the remote control to access and adjust each parameter.

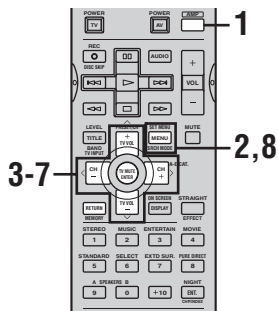

- You can change SET MENU parameters while the unit is reproducing sound.
- If you press a sound field program button during SET MENU operation, the SET MENU is canceled.

Note

You cannot change some SET MENU parameters while the unit is in either cinema or music night listening mode.

1 Press AMP.



2 Press SET MENU.



3 Press ^ / v to select MANUAL SETUP.

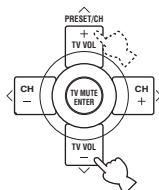

4 Press ENTER to enter MANUAL SETUP.

1 SOUND MENU appears on the front panel display.

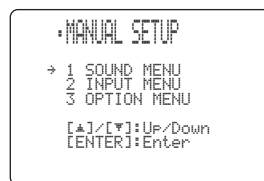
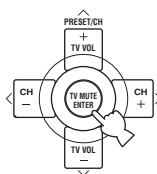

5 Press ^ / v to select the desired menu.

6 Press ENTER to enter the selected menu.

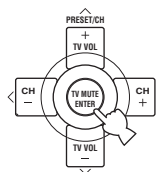

7 Press ^ / v and ENTER to select the submenu, then press ^ / v to select the item and < / > to change the parameter.

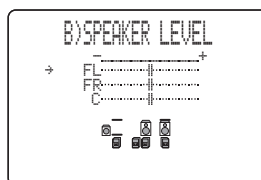

- Repeat this operation to select and adjust each setting.
- To return to the previous menu level, press RETURN.

8 To exit, press SET MENU when finished.



Memory back-up

The memory back-up circuit prevents the stored data from being lost even if this unit is in the standby mode. However, if the power cord is disconnected from the AC outlet, or the power supply is cut for more than one week, the stored data will be lost. If so, adjust the items again.

1 SOUND MENU

Use to manually adjust any speaker setting or compensate for video signal processing delays when using LCD monitors or projectors. Most of the SOUND MENU parameters are set automatically when you run auto setup (see page 24).



■ Speaker settings A) SPEAKER SET

Use to manually adjust any speaker setting.



If you are not satisfied with the bass sounds from your speakers, you can change these settings according to your preference.

Front speakers FRONT SP

Choices: **LARGE**, SMALL

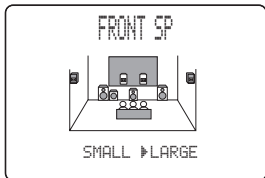

- Select **SMALL** if you have small front speakers. The unit directs the low-frequency signals of the front channel to the speakers selected with “LFE/BASS OUT”.
- Select **LARGE** if you have large front speakers. The unit directs the entire range of the front left and right channel signals to the front left and right speakers.

Center speaker CENTER SP

Choices: LRG, **SML**, NONE

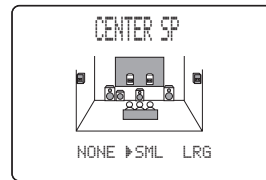

- Select **LRG** if you have a large center speaker. The unit directs the entire range of the center channel signal to the center speaker.
- Select **SML** if you have a small center speaker. The unit directs the low-frequency signals of the center channel to the speakers selected with “LFE/BASS OUT”.
- Select **NONE** if you do not have a center speaker. The unit directs all of the center channel signal to the front left and right speakers.

Surround left/right speakers SUR. L/R SP

Choices: LRG, **SML**, NONE

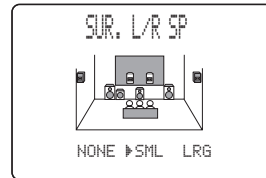

- Select **LRG** if you have large surround left and right speakers. The entire range of the surround channel signal is directed to the surround left and right speakers.
- Select **SML** if you have small surround left and right speakers. The low-frequency signals of the surround channel are directed to the speakers selected with “LFE/BASS OUT”.
- Select **NONE** if you do not have surround speakers. This will set the unit to the Virtual CINEMA DSP mode (see page 36) and automatically set the surround back speaker setting (SUR. B L/R SP) to **NONE**.

Surround back speakers SUR. B L/R SPChoices: LRGx1, LRGx2, **SMLx2**, SMLx1, NONE

- Select LRGx1 if you have a large surround back speaker. The unit directs the entire range of the surround back channel signal to the left surround back speaker.
- Select LRGx2 if you have 2 large surround back speakers. The unit directs the entire range of the surround back channel signal to the surround back speakers.
- Select SMLx2 if you have 2 small surround back speakers. The low-frequency signals of the surround back channels are directed to the speakers selected with “LFE/BASS OUT”.
- Select SMLx1 if you have a small surround back speaker. The low-frequency signals of the surround back channel are directed to the speakers selected with “LFE/BASS OUT”, and the rest of the frequency signals are directed to the left surround back speaker.
- Select NONE if you do not have a surround back speaker. The unit directs all of the surround back channel signal to the surround left and right speakers.

Note

If you select SMLx1 or LRGx1, connect the speaker to the left SURROUND BACK speaker terminals.

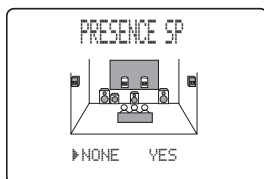
Presence speakers PRESENCE SPChoices: YES, **NONE**

- Select YES if you have presence speakers.
- Select NONE if you do not have presence speakers.



When YES is selected, the unit automatically adjusts the dialog lift parameter. To adjust it manually, see page 92.

Bass out LFE/BASS OUT

Low-frequency (bass) signals can be directed to the subwoofer and/or the front left and right speakers according to the characteristics of your system. This setting also determines the routing of the LFE (low-frequency effect) signals found in Dolby Digital or DTS sources.

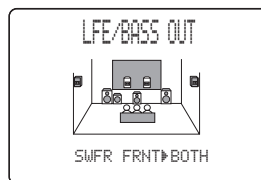
Choices: SWFR, FRNT, **BOTH**

- Select SWFR if you connect a subwoofer. LFE and low-frequency signals from other channels are directed to the subwoofer according to the speaker settings.
- Select FRNT if you do not use a subwoofer. LFE and low frequency signals from other channels are directed to the front speakers according to the speaker settings (even if you have previously set front speakers to SML).
- Select BOTH if you connect a subwoofer and you want to output low-frequency signals from front channels to both the front speakers and subwoofer. LFE and low-frequency signals from other channels are also directed to the subwoofer according to the speaker settings. Use this function to reinforce low-frequency signals using the subwoofer when playing back sources such as CDs.

Cross over CROSS OVER

Use this feature to select a cross-over (cut-off) frequency for all low-frequency signals. All frequencies below the selected frequency will be sent to the subwoofer.

Choices: 40Hz, 60Hz, **80Hz**, 90Hz, 100Hz, 110Hz, 120Hz, 160Hz, 200Hz

Subwoofer phase SUBWOOFER PHASE

If bass sounds are lacking or unclear, use this feature to switch the phase of your subwoofer.

Choices: **NORMAL**, REVERSE

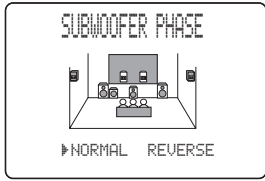

- Select **NORMAL** if you do not want to reverse the phase of your subwoofer.
- Select **REVERSE** to reverse the phase of your subwoofer.

Presence/Surround back channel priority PRIORITY

You can select to prioritize either the surround back or presence speakers when playing sources that contain surround back channel signals using CINEMA DSP sound field programs.

Choices: PRch, **SBCh**

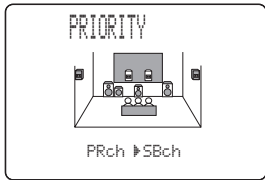

- Select **PRch** to use presence speakers even when surround back channel signals are input. The signals for the surround back channel will be output from surround speakers.
- Select **SBCh** to use surround back speakers when a surround back channel signal is detected in a CINEMA DSP program. Presence channel signals will be output from front speakers.

■ **Speaker level** B) SPEAKER LEVEL

Use these settings to manually balance the speaker level of each speaker selected in SPEAKER SET (page 64).

Choices: -10.0 dB to +10.0 dB

Initial Setting: 0 dB

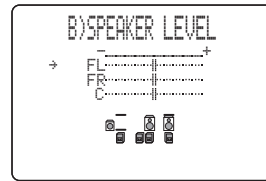

- **FL** adjusts the balance of the front left speaker.
- **FR** adjusts the balance of the front right speaker.
- **C** adjusts the balance of the center speaker.
- **SL** adjusts the balance of the surround left speaker.
- **SR** adjusts the balance of the surround right speaker.
- **SBL*** adjusts the balance of the surround back left speaker.
- **SBR*** adjusts the balance of the surround back right speaker.
- **SWFR** adjusts the balance of the subwoofer.
- **PL** adjusts the balance of the presence left speaker.
- **PR** adjusts the balance of the presence right speaker.

* Instead of SBL and SBR, SB will be displayed if you selected only one surround back speaker in SUR. B L/R SP (page 65).

■ Speaker distance C)SP DISTANCE

Use this feature to manually input the distance of each speaker and adjust the delay applied to respective channel. Ideally, each speaker should be the same distance from the main listening position. However, this is not possible in most home situations. Thus, a certain amount of delay must be applied to the sound from each speaker so that all sound will arrive at the listening position at the same time.

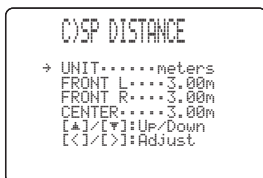

Unit UNIT

Choices: meters (m), feet (ft)

Initial setting:

U.S.A. and Canada models: feet (ft)

Other models: meters (m)

- Select meters to input speaker distances in meters.
- Select feet to input speaker distances in feet.

Speaker distances

Choices: 0.3 to 24.00 m (1 to 80 ft)

- **FRONT L** adjusts the distance of the front left speaker. Initial setting: 3.0 m (10.0 ft)
- **FRONT R** adjusts the distance of the front right speaker. Initial setting: 3.0 m (10.0 ft)
- **CENTER** adjusts the distance of the center speaker. Initial setting: 3.0 m (10.0 ft)
- **SUR. L** adjusts the distance of the surround left speaker. Initial setting: 3.0 m (10.0 ft)
- **SUR. R** adjusts the distance of the surround right speaker. Initial setting: 3.0 m (10.0 ft)
- **SB L*** adjusts the distance of the surround back left speaker. Initial setting: 2.10 m (7.0 ft)
- **SB R*** adjusts the distance of the surround back right speaker. Initial setting: 2.10 m (7.0 ft)
- **SWFR** adjusts the distance of the subwoofer. Initial setting: 3.0 m (10.0 ft)
- **PRES L** adjusts the distance of the presence left speaker. Initial setting: 3.0 m (10.0 ft)
- **PRES R** adjusts the distance of the presence right speaker. Initial setting: 3.0 m (10.0 ft)

* Instead of SB L and SB R, SUR. B will be displayed if you selected only one surround back speaker in SUR. B L/R SP (page 65).

■ Center graphic equalizer D)EQUALIZER

Use this feature to select the parametric (AUTO PEQ) or graphic equalizer (CNTR GEQ).

Equalizer EQ TYPE SELECT

Select to change the type of equalizer used by this unit.

Choices: AUTO PEQ, **CNTR GEQ**, EQ OFF

- Select AUTO PEQ to use the equalizer adjusted in auto setup.
- Select CNTR GEQ to adjust the built-in 5-band graphic equalizer so that the tonal quality of the center speaker matches that of the front left and right speakers.
- Select EQ OFF to cancel equalizing.

Center graphic equalizer CENTER GEQ

When CNTR GEQ is selected, use this feature to output a test tone and adjust the tonal quality so that it matches that of the front left speaker.

You can adjust 5 frequency bands:

100Hz, 300Hz, 1kHz, 3kHz, 10kHz

Choices: -6 to +6 dB

Initial setting: 0 dB

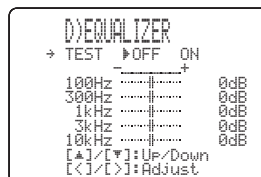

- Select ON to output test tones from the front left and center speakers, and adjust the tonal quality of the center speaker.
- Select OFF to stop the test tone and output the currently selected source component.
- Press ^ / v to select a frequency band.
- Press < / > to adjust the selected frequency band.

■ **Low-frequency effect level** E>LFE LEVEL

Use to adjust the output level of the LFE (low-frequency effect) channel according to the capacity of your subwoofer or headphones. The LFE channel carries low-frequency special effects which are only added to certain scenes. This setting is effective only when this unit decodes Dolby Digital or DTS signals.

Choices: -20 to **0** dB



Speaker SPEAKER

Select to adjust the speaker LFE level.

Headphone HEADPHONE

Select to adjust the headphone LFE level.

Note

Depending on the settings of “LFE LEVEL”, some signals may not be output from the SUBWOOFER OUTPUT jack.

■ **Dynamic range** F>DYNAMIC RANGE

Use to select the amount of dynamic range compression to be applied to your speakers or headphones. This setting is effective only when the unit is decoding Dolby Digital and DTS signals.

Choices: MIN (minimum), STD (standard), **MAX** (maximum)

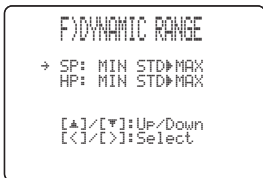

Speaker SP

Select to adjust the speaker compression.

Headphone HP

Select to adjust the headphone compression.

- Select MIN if you regularly listen at low volume levels.
- Select STD for general use.
- Select MAX to preserve the greatest amount of dynamic range.

■ **Audio settings** G>AUDIO SET

Use to customize this units overall audio settings.



Muting type MUTING TYPE

Use to adjust how much the mute function reduces the output volume.

Choices: **FULL**, -20dB

- Select FULL to completely halt all output of sound.
- Select -20dB to reduce the current volume by 20 dB.

Audio delay AUDIO DELAY

Use to delay the sound output and synchronize it with the video image. This may be necessary when using certain LCD monitors or projectors.

Choices: **0** to 160 ms

Tone bypass TONE BYPASS

Use to select whether audio output bypasses tone control circuitry when TREBLE and BASS are set to 0 dB (see page 31).

Choices: **AUTO**, OFF

- Select AUTO if you want signals to bypass tone control circuitry to provide the purest signal possible.
- Select OFF if you do not want signals to bypass tone control circuitry.

2 INPUT MENU

Use to reassign digital input/outputs, select the input mode or rename your inputs.

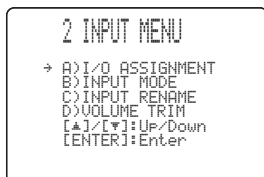

■ Input/output assignment

A) I/O ASSIGNMENT

You can assign jacks according to the component to be used if this unit's initial settings do not correspond to your needs. Change the following parameters to reassign the respective jacks and effectively connect more components.

Once the inputs have been reassigned, you can select the corresponding component by using INPUT on the front panel or the input selector buttons on the remote control.

For COMPONENT VIDEO jacks A (CMPNT-V INPUT [A]) and B (CMPNT-V INPUT [B])

Choices: [A] **DVD**, DTV/CBL, V-AUX, VCR1, DVR/VCR2
 [B] **DVD**, **DTV/CBL**, V-AUX, VCR1, DVR/VCR2

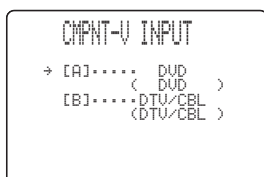

For OPTICAL OUTPUT jack 1 (OPTICAL OUT (1))

Choices: PHONO, CD, **MD/CD-R**, DVD, DTV/CBL, V-AUX, VCR1, DVR/VCR2

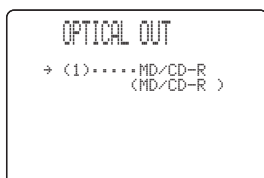

For OPTICAL INPUT jack 2 (OPTICAL IN (2)), 3 (OPTICAL IN (3)) and 4 (OPTICAL IN (4))

Choices: (2) PHONO, CD, **MD/CD-R**, DVD, DTV/CBL, VCR1, DVR/VCR2
 (3) PHONO, CD, MD/CD-R, **DVD**, DTV/CBL, VCR1, DVR/VCR2
 (4) PHONO, CD, MD/CD-R, DVD, **DTV/CBL**, VCR1, DVR/VCR2

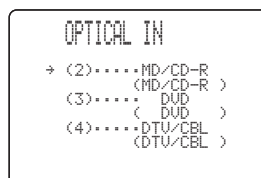

For COAXIAL INPUT jacks 5 (COAXIAL IN (5)) and 6 (COAXIAL IN (6))

Choices: (5) PHONO, **CD**, MD/CD-R, DVD, DTV/CBL, V-AUX, VCR1, DVR/VCR2
 (6) PHONO, CD, MD/CD-R, **DVD**, DTV/CBL, V-AUX, VCR1, DVR/VCR2

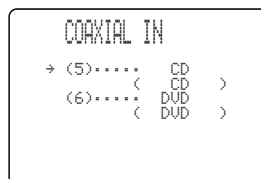

Notes

- You cannot select a specific item more than once for the same type of jack.
- When you connect a component to both the COAXIAL and OPTICAL jacks, priority is given to the input signals from the COAXIAL jack.

■ Input mode B) INPUT MODE

Use this feature to designate the input mode for sources connected to the DIGITAL INPUT jacks when you turn on this unit (see page 37 for details about the input mode).

Choices: **AUTO**, **LAST**



- Select **AUTO** to allow this unit to automatically detect the type of input signal and select the appropriate input mode.
- Select **LAST** to set this unit to automatically select the last input mode used for that source.

Note

Even if **LAST** is selected, the last setting for the EX/ES button will not be recalled.

■ Input rename C) INPUT RENAME

Use this feature to change the name of the inputs on the OSD and front panel display.



1 Press an input selector button to select the input you want to change the name of.

2 Press AMP.

3 Press </> to place the _ (under-bar) under the space or the character you want to edit.

4 Press ^/∨ to select the character you want, then use </> to move to the next space.

- You can use up to 8 characters for each input.
- Press ∨ to change the character in the following order, or press ^ to go in the reverse order:
A to Z, a space, 0 to 9, a space, a to z, a space, symbols (#, *, -, +, etc.)

5 Repeat steps 1 through 4 to rename each input.

6 To exit, press SET MENU when finished.

■ Volume Trim D) VOLUME TRIM

Use this feature to adjust the level of the signal input to each jack. This is useful if you want to balance the level of each input source to avoid sudden changes in volume when switching between input sources.

Choices: **PHONO**, **CD**, **MD/CD-R**, **TUNER**, **DVD**, **DTV/CBL**, **V-AUX**, **VCR1**, **DVR/VCR2**

3 OPTION MENU

Use to adjust the optional system parameters.

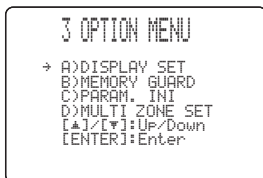

■ Display settings A)DISPLAY SET

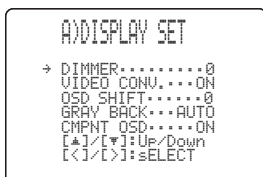

Dimmer DIMMER

Use to adjust the brightness of the front panel display.

Choices: -4 to 0

Video conversion VIDEO CONV.

Use this feature to turn on/off conversion of composite (VIDEO) signals to both S-video and component signals. This allows you to output converted video signals from the S VIDEO or COMPONENT VIDEO jacks when no S-video or component signals are input. This feature also converts S-video signals to component signals when no component signals are input.

Choices: **ON**, OFF

- Select OFF not to convert any signals. (except S-video signals to composite signals)
- Select ON to convert composite signals to S-video and component signals, and to convert S-video signals to component signals.
- Regardless of the setting, S-video signals are always converted to composite signals.

Notes

- Converted video signals are only output to the MONITOR OUT jacks. When recording you must make the same type of video connections (i.e., S-video) between each component.
- When converting composite video or S-video signals from a VCR to component video signals, the picture quality may suffer depending on your VCR.

OSD shift OSD SHIFT

Use to adjust the vertical position of the OSD.

Choices: +5 (downward) to -5 (upward)

- Press + to lower the position of the OSD.
- Press - to raise the position of the OSD.

Gray back GRAY BACK

Selecting AUTO for the on-screen display setting displays a gray background when there's no video signal input. Nothing is displayed if OFF is selected.

Choices: **AUTO**, OFF

Notes

- When only the component video signals are input, the OSD is not displayed if GRAY BACK is set to OFF. To display the OSD with component video signal input, set GRAY BACK to AUTO while the OSD mode (see page 59) is set to "Full Display".
- When video signals are not being input, set GRAY BACK to AUTO to display the OSD.

Component OSD CMPNT OSD

Use this feature to turn on/off OSD output to the COMPONENT VIDEO MONITOR OUT jacks when using the SET MENU.

Choices: **ON**, OFF

- Select ON to output the OSD signals from COMPONENT VIDEO MONITOR OUT jacks.
- Select OFF if you do not want to output the OSD signals from COMPONENT VIDEO MONITOR OUT jacks.

Note

SET MENU functions even when OFF is selected.

■ Memory guard B)MEMORY GUARD

Use this feature to prevent accidental changes to DSP program parameter values and other system settings.

Choices: **OFF**, ON

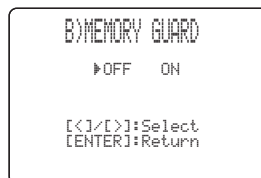

Select ON to protect:

- DSP program parameters
- All SET MENU items
- All speaker levels
- The on-screen display (OSD) mode

Note

When MEMORY GUARD is set to ON, you cannot select any other SET MENU items.

Parameter initialization C)PARAM. INI

Use this feature to initialize the parameters for each sound field program within a sound field program group. When you initialize a sound field program group, all of the parameter values within that group revert to their initial settings.

Press the corresponding numeric button for the sound field program that you want to initialize.

Choices:

An asterisk (*) appears next to program numbers that have been changed from their initial settings.

Choices: STEREO, MUSIC, ENTERTAINMENT, MOVIE, STANDAND



Notes

- You cannot automatically revert to the previous parameter settings once you initialize a sound field program group.
- You cannot separately initialize individual sound field programs.
- You cannot initialize any program groups when “MEMORY GUARD” is set to ON.

Zone set D) MULTI ZONE SET

Use to specify the location of speakers connected to the SPEAKERS B terminals.



Speaker B setting SP B

Use this feature to select the location of the front speakers connected to the SPEAKERS B terminals.

Choices: **FRONT**, ZONE B

- Select FRONT to turn on/off SPEAKERS A and B when the speakers connected to the SPEAKERS B terminals are set in the main room.
- Select ZONE B if the speakers connected to the SPEAKERS B terminals are set in another room. If SPEAKERS A is turned OFF and SPEAKERS B is turned ON, all the speakers including the subwoofer in the main room are muted and the unit outputs sound from SPEAKERS B only.

Notes

- If you connect headphones to the PHONES jack on the unit when “SP B” is set to ZONE B, the sound is output from both headphones and SPEAKERS B.
- If a DSP program is selected when “SP B” is set to ZONE B, the unit automatically enters the Virtual CINEMA DSP mode.

Zone 2 amplifier ZONE2 AMP

(U.S.A., Canada, Australia and Europe models only)

Use to select how the ZONE 2 speakers will be amplified.

Choices: INT, **EXT**

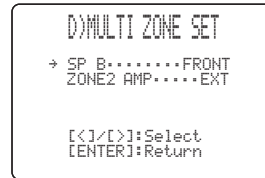

- Select EXT if you do not use Zone 2 speakers or if you connect your Zone 2 speakers through an external amplifiers connected to this unit’s ZONE 2 OUTPUT jacks.
- Select INT to use this unit’s internal amplifier if you connect your Zone 2 speakers directly to this unit’s PRESENCE/ZONE 2 speaker terminals.

XM Radio setting E)XM RADIO SET

XM information display time

XM DISPLAY

Use to set the time for displaying XM information in the on-screen display. If “10s” or “30s” is selected, xm information is displayed for 10 or 30 seconds after pressing DISPLAY.

Choices: OFF, **10s**, 30s, ON



When “XM DISPLAY” in the SET MENU is set to “ON”, pressing DISPLAY shows xm information until you select another input source (see page 30).

XM Radio antenna XM ANT.

Use to check the current reception level for the XM connect and Play digital antenna accessory connected to this unit. For the best reception, orient the XM connect and Play digital antenna accessory so that a value of XX% or more is displayed here.

Range: NONE, 0 to 100%

Note

“NONE” is displayed if the XM connect and Play digital antenna accessory is not connected to this unit. If this happens, check the antenna connections (see page 45).

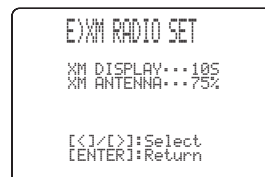

ADVANCED SETUP MENU

The ADVANCED SETUP menu is displayed in the front panel display.



- During the advanced setup procedure, audio output is muted.
- During the advanced setup procedure, only the STANDBY/ON, STRAIGHT (EFFECT) buttons, and PROGRAM selector on the front panel are available for operation.

CAUTION

Be sure to set the speaker impedance before using this unit to play back audio or video signals.

(U.S.A. model)

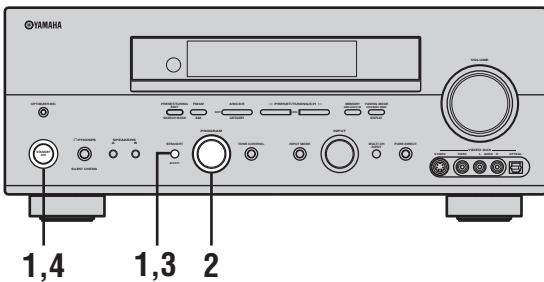

- 3 Press **STRAIGHT (EFFECT)** repeatedly to toggle between the available parameters.

STRAIGHT



- 4 Press **STANDBY/ON** to confirm your selection.



This completes the advanced setup procedure. The settings you made are reflected the next time this unit's power is turned on.

- 1 Turn off the power to this unit, and while holding down **STRAIGHT (EFFECT)**, press **STANDBY/ON**.

This unit turns on, and the ADVANCED SETUP menu appears in the front panel display.

STRAIGHT



While holding down, press



- 2 Rotate **PROGRAM** to move through the menu and select the item you want to set up.

See the end of this section for a complete list of available parameters.

PROGRAM



ADVANCED SETUP menu items

Change the initial settings (indicated in bold under each parameter) to reflect the needs of your listening environment.

Speaker impedance SP IMP.

Use to switch the speaker impedance for this unit.

Choices: **8 Ω MIN**, 4 Ω MIN

- Select 8 Ω MIN to set the speaker impedance to 8 Ω
- Select 4 Ω MIN to set the speaker impedance to 4 Ω

SP IMP.	Speaker	Impedance level
4 Ω MIN	Front	If you use one set (A or B), the impedance of each speaker must be 4 Ω or higher.
		If you use two sets (A and B), the impedance of each speaker must be 8 Ω or higher.
	Center	The impedance of each speaker must be 6 Ω or higher.
	Surround	
	Surround back	
8 Ω MIN	Front	If you use one set (A or B), the impedance of each speaker must be 8 Ω or higher.
		If you use two sets (A and B), the impedance of each speaker must be 16 Ω or higher.*
	Center	The impedance of each speaker must be 8 Ω or higher.
	Surround	
	Surround back	

- The Canada model cannot use two separate speaker systems (A and B) simultaneously when SP IMP is set to the 8 Ω MIN position.

Factory presets PRESET

Use to reset all parameters to the factory presets (see page 98).

Choices: **CANCEL**, RESET

- Select CANCEL if you do not want this unit's parameters to be initialized when you reset the factory presets.
- Select RESET if you want all of this unit's parameters to be initialized when you reset the factory presets.

Note

This setting does not affect ADVANCED SETUP menu item parameters.

Remote REMOTE

Use to switch the ID for the remote control of this unit.

Choices: **ID1**, ID2

- Select ID1 to operate this unit using the default code.
- Select ID2 to operate this unit using an alternative code.

Note

You must also make settings for the remote control (see page 76).

< Asia and General models only >

Tuner TU

Use to switch the frequency step selection according to the frequency spacing in your area.

Choices: **AM10/FM100**, AM9/FM50

- North, Central and South America: AM10/FM100 (kHz)
- Other areas: AM9/FM50 (kHz)

REMOTE CONTROL FEATURES

In addition to controlling this unit, the remote control can also operate other A/V components made by YAMAHA and other manufacturers. To control other components, you must set up remote control with the appropriate remote control codes. This remote control also has a learn feature which allows the remote to acquire functions from other remote controls equipped with an infrared remote control transmitter.

Control area

■ Controlling this unit

The shaded areas below can be used to control this unit after pressing AMP to activate the AMP mode.

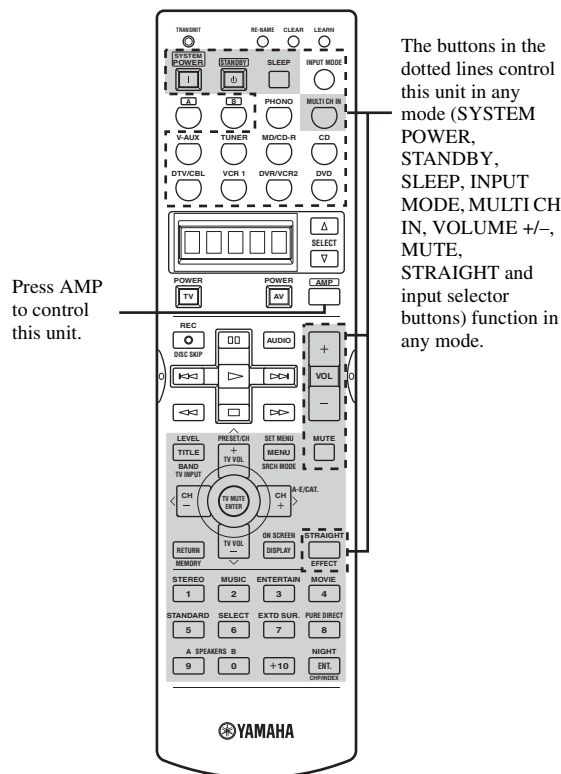

Fixing the remote to AMP mode

You can fix the remote permanently to AMP mode (fixed AMP mode) so that the shaded areas above always control this unit. This is useful, if you primarily want to use the remote control in AMP mode. To fix AMP mode, hold down AMP for at least 3 seconds so that "A:___" appears in the display window.



To temporarily switch to component control mode, press AMP. To cancel fixed AMP mode, hold down AMP for at least 3 seconds.

■ Controlling other components

The shaded areas below can be used to control other components. Each button has a different function depending on the selected component. Select the component you want to control by pressing an input selector button or SELECT Δ/∇ . The name of the selected component appears in the display window.

The A/B and input selector buttons switch the function of the component control area below.

* Use the A/B buttons to control other components regardless of whether they are connected to this unit.

Factory setting:

A...LD player

B...CD recorder

SELECT Δ/∇ switches control to another component without changing the input source on this unit.

Component control area

You can control up to 11 different components by setting appropriate remote control codes (see page 76).

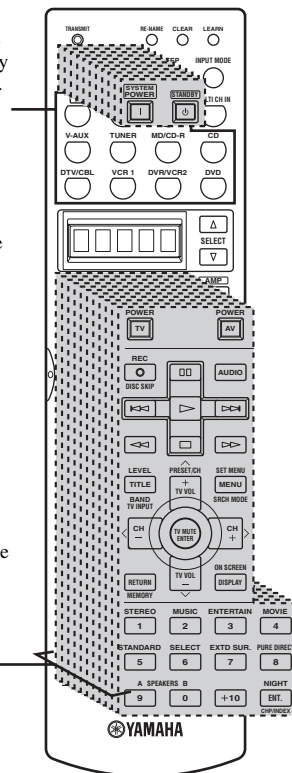

ADVANCED OPERATION

Setting remote control codes

You can control other components by setting the appropriate manufacturer codes. Codes can be set up for each input area.

The following table shows the factory preset component (Library: component category) and the manufacturer code for each area.

Remote Control Code Default Settings

Input area	Component category (Library)	Manufacturer
A	LD	Yamaha (U.K. and Europe models) Yamaha-1 (Other models)
B	CD-R	Yamaha
PHONO	TV	-
V-AUX	VCR	-
TUNER	TUNER	Yamaha-3 (U.K. and Europe models) Yamaha-4 (Other models)
MD/CD-R	MD	Yamaha-1
CD	CD	Yamaha-1
DTV/CBL	TV	-
VCR 1	VCR	-
DVR/VCR2	DVR	Yamaha
DVD	DVD	Yamaha-1

Note

You may not be able to operate your YAMAHA component even if a YAMAHA remote control code is initially set as listed above. In this case, try to set other YAMAHA remote control code(s).

1 Press an input selector button to select the source component you want to set up.

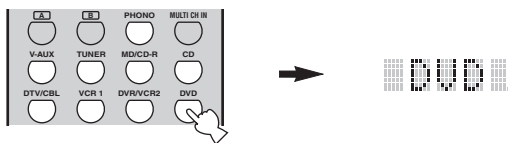

2 Press and hold LEARN for about 3 seconds using a ballpoint pen or similar object.

“SETUP” and the selected component name appear alternately in the display window.

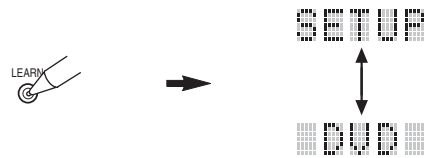

Be sure to press and hold LEARN for at least 3 seconds, otherwise the learning process will start.



Complete each of the following steps in 30 seconds. Otherwise, the learning mode will be automatically canceled. In this case, press LEARN again.

If you want to change a library (component category), press </>. You can set a different type of component.

Library choices: L:DVD, L:DVR, L:LD, L:CD, L:CDR, L:MD, L:TAP (tape), L:TUN, L:AMP*, L:TV, L:CAB (cable), L:DBS, L:SAT, L:VCR

- The amplifier Library (L:AMP) code is preset to “ID1” to operate this unit. However, you can switch between the following two codes if necessary.

The initial setting for “Amplifier library” is “ID1”.

AMP library code (remote control setting)	Function	Remote control ID (this unit's setting: see page 74)
ID1 (initial setting)	To operate this unit using the default code.	ID1 (initial setting)
ID1Z	To operate this unit using the default code. To operate Zone 2 or Zone 3 features (see page 83). (U.S.A., Canada, Europe and Australia models only)	
ID2	To operate this unit using an alternative code.	ID2
ID2Z	To operate this unit using an alternative code. To operate Zone 2 or Zone 3 features (see page 83). (U.S.A., Canada, Europe and Australia models only)	

When using multiple YAMAHA receivers/amplifiers, you may be able to operate the other components simultaneously with the default code setting. In this case, set one of the alternative codes to operate this unit separately

3 Press \wedge / \vee to select the name of your component's manufacturer.

You will find the names of most worldwide audio-video manufacturers in alphabetical order in the display window.

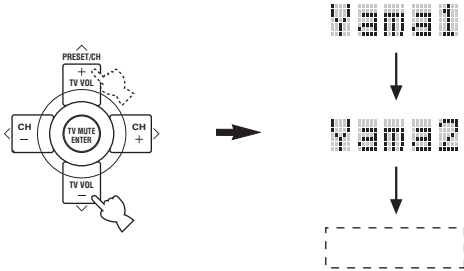

4 Press one of the buttons shaded below to see if you can control your component. If you can, the manufacturer code is correct.

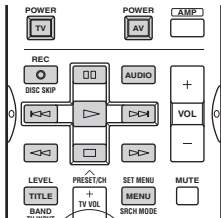

- If the manufacturer of your component has more than one codes, try each of them until you find the correct one.
- If you continuously want to set up a code for another component, press TV MUTE/ENTER and repeat steps 1, 3 and 4.

5 Press LEARN again to exit from the setup mode.



Notes

- The supplied remote control does not contain all possible manufacturer codes for commercially available AV components (including YAMAHA AV components). If operation is not possible with any of the manufacturer codes, program the new remote control function with the Learn feature (see below) or use the remote control supplied with the component.
- If you have already programmed a remote control function for a button, the function by learning programming takes priority over the setup manufacturer code's function.
- "ERROR" appears in the display window if you press a button not indicated in the respective step, or when you press more than one button at the same time.

Controlling other components

Once you set the appropriate remote control codes, you can use this remote to control your other components. Note that some buttons may not correctly operate the selected component. Use the input selector buttons to select the component you want to operate. The remote control automatically switches to the appropriate control mode for that component.

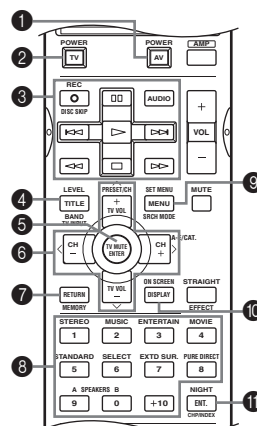

	DVD player/ DVD recorder	VCR	Digital TV/ Cable TV	LD player	CD player	MD/CD recorder	Tuner *4
1 AV POWER	Power *1	Power *1	VCR power *3	Power *1	Power *1	Power *1	Power *1
2 TV POWER	TV power *2	TV power *2	TV power	TV power *2	TV power *2	TV power *2	TV power *2
3 REC/DISC SKIP	Disc skip (player) Rec (recorder)	Rec	VCR rec *3		Disc skip	Rec (MD)	
▷	Play	Play	VCR play *3	Play	Play	Play	
◁◁	Search backward	Search backward	VCR search backward *3	Search backward	Search backward	Search backward	
▷▷	Search forward	Search forward	VCR search forward *3	Search forward	Search forward	Search forward	
AUDIO	Audio			Sound			
⏸	Pause	Pause	VCR pause *3	Pause	Pause	Pause	
◁◁◁	Skip backward			Skip backward	Skip backward	Skip backward	
▷▷▷	Skip forward			Skip forward	Skip forward	Skip forward	
□	Stop	Stop	VCR stop *3	Stop	Stop	Stop	
4 TITLE/ TV INPUT	Title	TV input *2	TV input	TV input *2	TV input *2	TV input *2	Band
5 TV MUTE/ ENTER	Select	TV mute *2	TV mute	TV mute *2	TV mute *2	TV mute *2	
6 TV VOL +	Up	TV volume + *2	TV volume +	TV volume + *2	TV volume + *2	TV volume + *2	Preset up (1 – 8)
TV VOL –	Down	TV volume – *2	TV volume –	TV volume – *2	TV volume – *2	TV volume – *2	Preset down (1 – 8)
CH +	Right	VCR channel +	TV channel +	TV channel + *2	TV channel + *2	TV channel + *2	Preset up (A – E)
CH –	Left	VCR channel –	TV channel –	TV channel – *2	TV channel – *2	TV channel – *2	Preset down (A – E)
7 RETURN	Return						
8 1-9, 0, +10	Numeric buttons	Numeric buttons	Numeric buttons	Numeric buttons	Numeric buttons	Numeric buttons	Preset stations (1-8)
9 MENU	Menu						
10 DISPLAY	Display		Display	Display	Display	Display	
11 ENT.	Title/Index	Enter	Enter	Chapter/Time	Index	Index	

*1 This button functions only when the original remote control of the component has a POWER button.

*2 These buttons can operate your TV without switching the input if the remote control code is set in DTV/CBL or PHONO. When the remote control code for your TV is set up in both the DTV/CBL and PHONO areas, priority is given to the signal in the DTV/CBL area.

*3 These buttons can operate your VCR without switching the input to VCR 1 if the remote control code is set in VCR 1.

*4 The U.K. model is not equipped with the tuner reception function.

Programming codes from other remote controls

If you want to program functions not included in the basic operations covered by the remote control code, or an appropriate remote control code is not available, do the following. You can program any of the buttons available in the component control area (see page 75). The buttons can be programmed independently for each component.

Note

This remote control transmits infrared rays. If the other remote control also uses infrared rays, this remote control can learn most of its functions. However, you may not be able to program some special signals or extremely long transmissions. (Refer to the operating instructions for the remote control of your component.)

- 1 Press an input selector button to select a source component.**

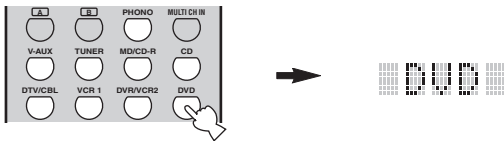

- 2 Place this remote control about 5 to 10 cm apart from the other remote control on a flat surface so that their infrared transmitters are aimed at each other.**

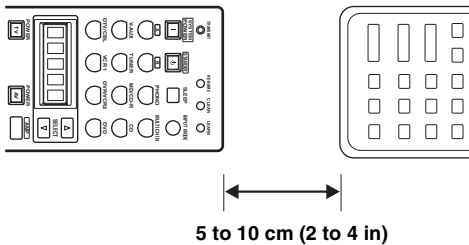

- 3 Press LEARN using a ballpoint pen or similar object.**

Do not press and hold LEARN. If you hold it down for more than three seconds, the remote enters the manufacturer code setting mode.

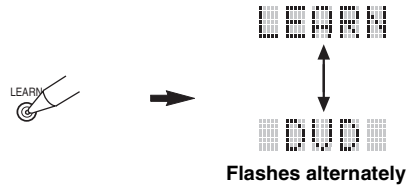

Complete each of the following steps in 30 seconds. Otherwise, the learning mode will be automatically canceled. In this case, press LEARN again.

- 4 Press the button at which you want to program the new function.**

“LEARN” is displayed.

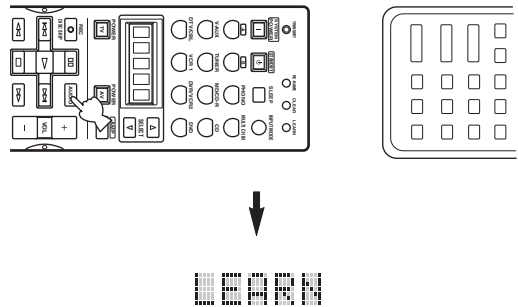

- 5 Press and hold the button you want to program on the other remote control until “OK” appears in the display window.**

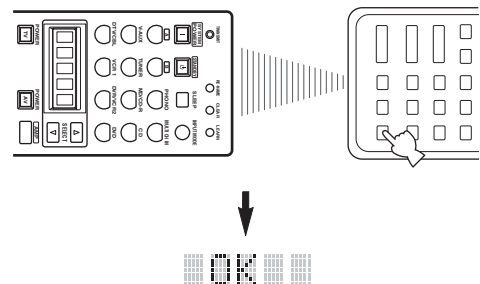

Notes

- “NG” appears in the display window if programming was unsuccessful. In this case, start over from step 4.
- This remote control can learn approximately 120 functions. However depending on the signals learned, “FULL” may appear in the display before you program 120 functions. In this case, clear unnecessary programmed functions to make room for further learning.

6 Repeat steps 4 and 5 to program additional functions.

7 Press LEARN again to exit from the learning mode.



Notes

- Learning may not be possible in the following cases:
 - When the batteries in the remote control for this unit or other components are weak.
 - When the distance between the two remote controls is too great or too small.
 - When the remote control infrared windows are not facing at the appropriate angle.
 - When the remote control is exposed to direct sunlight.
 - When the function to be programmed is continuous or uncommon.
- “ERROR” appears in the display window if you press more than one button at the same time.

Changing source names in the display window

You can change the name that appears in the display window on the remote control if you want to use a different name to the one that is set as the factory preset. This is useful when you have set the input selector to control a different component.

1 Press an input selector button to select the source component you want to rename.
The selected component name appears in the display window.

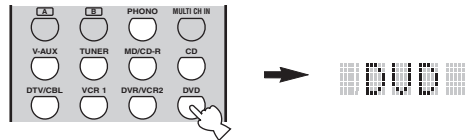

2 Press RE-NAME using a ballpoint pen or similar object.



3 Press ^ / v to select and enter a character.
Pressing v changes the character as follows: A to Z, a to z, 0 to 9, space, -(hyphen), and /(slash). (Pressing ^ changes the characters in reverse order.)

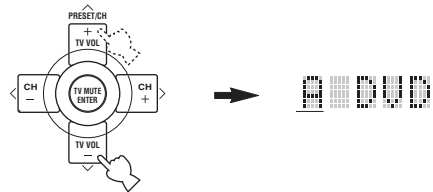

4 Press < / > to move the cursor to the next position.

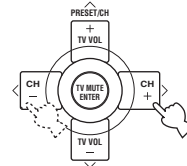

If you want to continue setting up names for other components, press TV MUTE/SELECT and repeat steps 1, 3 and 4.

5 Press RE-NAME again to exit from the renaming mode.



Clearing function sets

You can clear all changes made in each function set, such as learned functions, renamed source names and setup manufacturer codes.

1 Press CLEAR by using a ballpoint pen or similar object.



Complete each of the following steps in 30 seconds. Otherwise, the learning mode will be automatically canceled. In this case, press CLEAR again.

2 Press \wedge / \vee to select the clear mode.

- L: DVD (L: name of a component)
Clears all learned functions in the respective component control area. Press an input selector button to select the component.
- L: AMP Clears all learned functions for this unit's control area.
- L: ALL Clears all learned functions.
- RNAME Clears all renamed source names.
- FCTRY Clears all remote functions and returns the remote to the factory settings.

3 Press and hold CLEAR again for about 3 seconds.

“C:OK” appears in the display window.

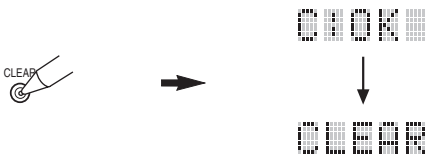

Note

“C:NG” appears in the display window if the operation is unsuccessful. In this case, start over from step 2.

4 Press CLEAR to exit from the clearing mode.

Once you have cleared a learned function for a button, the button reverts to the factory preset setting.



Note

“ERROR” appears in the display window under the following circumstances:

- When a button other than the cursor is pressed.
- When more than one button is pressed at the same time.

Clearing individual functions

■ Clearing a learned function

You can clear the function learned in a certain programmed button in each area.

- 1 Press an input selector button to select the source component containing the function you want to clear.**

The selected component name appears in the display window.

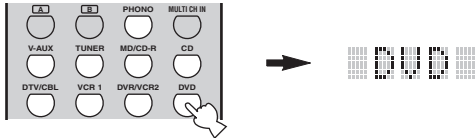

- 2 Press LEARN using a ballpoint pen or similar object.**

“LEARN” and the selected component name appear alternately in the display window.

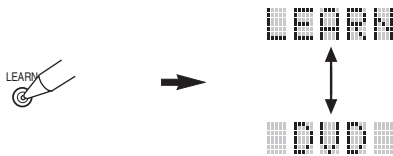

Complete each of the following steps in 30 seconds.

Otherwise the learning mode will be automatically canceled.

In this case, press LEARN again.

- 3 Press and hold CLEAR using a ballpoint pen or similar object, then press the button you want to clear for about 3 seconds.**

“C:OK” appears in the display window.

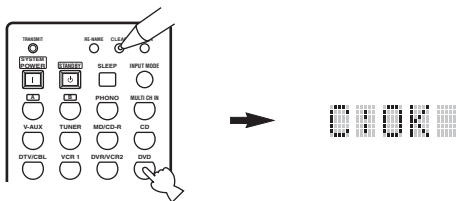

When you clear a learned function, the button reverts to the factory preset setting (or manufacturer setting if you have set manufacturer codes).

- 4 Repeat step 3 to clear other learned functions.**

- 5 Press LEARN again to exit.**

ZONE 2 (U.S.A., CANADA, AUSTRALIA AND EUROPE MODELS ONLY)

This unit allows you to configure a multi-room audio system. You can control this unit from the second room using the supplied remote control.

Only analog signals are sent to the second room. Any source you want to listen to in the second room must be connected using the analog (AUDIO L/R) input jacks on this unit.

Zone 2 connections

You need the following additional equipment to use the multi-room functions of this unit:

- An infrared signal receiver in the second room.
- An infrared emitter in the main room. This emitter transmits the infrared signals from the remote control in the second room to the main room (to a CD player, for example).
- An amplifier and speakers for the second room.

- ☛
- Since there are many possible ways to connect and use this unit in a multi-room installation, we recommend that you consult with your nearest authorized YAMAHA dealer or service center about the Zone 2 connections that best meet your requirements.
 - Some YAMAHA models are able to connect directly to the REMOTE CONTROL OUT jack of this unit. If you own these products, you may not need to use an infrared emitter. Up to 6 YAMAHA components can be connected as shown.

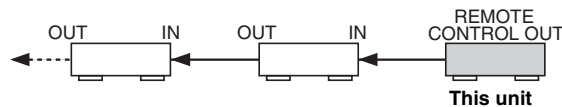

■ System configuration and connections example

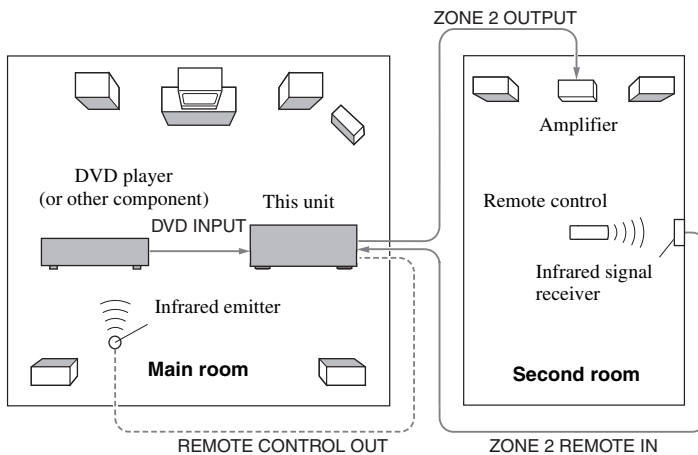

Notes

- When not using the main room, turn down the volume of this unit in the main room. Adjust the volume control on the amplifier in the second room.
- To avoid unexpected noise, DO NOT USE the Zone 2 feature with CDs encoded in DTS.

Using this unit's internal amplifier

To use this unit's internal amplifier, set "ZONE2 AMP" to "INT" in SET MENU (see page 72).

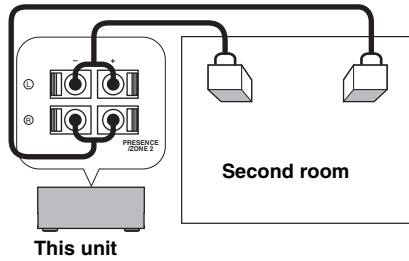

Remote controlling Zone 2

The supplied remote control can be used to control Zone 2. You can even select the input source and control components located in the main room directly from the second room regardless of the listening condition in the main room.



You can also turn on/off the MAIN and ZONE 2 mode by pressing MAIN or ZONE 2 on the front panel.

To enable Zone 2 mode on the remote control

You will be able to switch the remote control mode from one room to another, and use STANDBY, SYSTEM POWER, MUTE and VOL -/+ to control the selected room.

1 Repeat steps 1 and 2 of the procedure in "Setting remote control codes" on page 76.

2 Press </> to select "L:AMP".

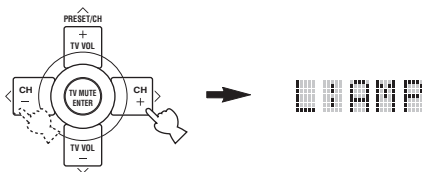

3 Press ^ / v to select "ID1Z".

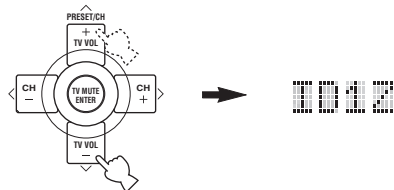

Notes

- To select the Zone feature with ID2, select "ID2Z".
- Since the Zone 2 code is common to "ID1Z" and "ID2Z", the Zone 2 code does not change even if the AMP library code (remote control setting) is switched.

4 Press LEARN to complete the Zone setup.

The remote control will be able to operate this unit and Zone 2.



To control Zone 2

1 Press SELECT Δ repeatedly to display "ZONE2" in the display window.

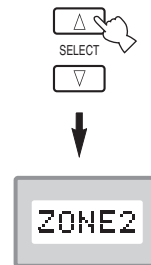

2 Press SYSTEM POWER to turn Zone 2 power on.

3 Press an input selector button to select the input source you want to listen to in the second room.

The display window shows “2: name of selected input” if the remote control is in the Zone 2 mode.

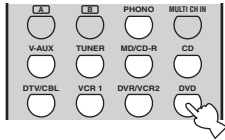

4 You can control Zone 2 using the input selector, STANDBY, SYSTEM POWER, MUTE and VOL +/-.

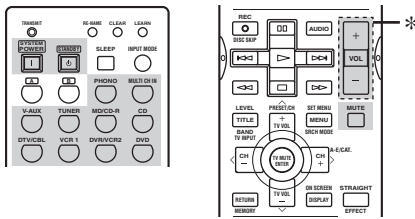

* If “ZONE2 AMP” in OPTION MENU is set to INT, you can use VOL +/- to adjust sound output from speakers connected to the PRESENCE/ZONE 2 speaker terminals (see page 72). However, VOL +/- cannot be used to adjust sound output from the ZONE2 OUTPUT jacks.

5 Press SELECT Δ/∇ to exit from the Zone 2 mode.

Notes

- “ZONE2” will appear in the display window only when Δ is pressed, and SYSTM only when ∇ is pressed.
- If you press SELECT Δ when the unit is set to Zone 2 mode, the unit switches to Zone 3 mode. However, this unit does not support Zone 3 mode. To exit Zone 3 mode, press SELECT ∇ .
- Since the Zone 2 code is common to “ID1Z” and “ID2Z”, the Zone 2 code does not change even if the AMP library code (remote control setting) is switched.

Turning this unit to either on or standby
SYSTEM POWER and STANDBY work differently depending on the selected mode that appears on the display window.

- When normal, Zone 2 mode is selected, you can turn the main unit, Zone 2 to on/standby individually.
- When system mode is selected, or when ID1/ID2 is selected as the amplifier library (L:AMP) code, you can turn the main unit, Zone 2 to on/standby all together simultaneously.

	LCD display	SYSTEM POWER/STANDBY
Normal mode*	Name of component	Turns the main unit on/standby
Zone 2 mode	“ZONE2” or “2:name of component”	Turns Zone 2 to on/standby
System mode	“SYSTM”	Turns everything (the main unit and Zone 2) on/standby

* “MAIN” appears for a few seconds when SYSTEM POWER or STANDBY is pressed.

Special considerations for DTS software

The DTS signal is a digital bitstream. If you attempt to send the DTS signal to the second room you will only hear digital noise (that may damage your speakers). Thus, the following considerations and adjustments need to be made when playing DTS-encoded discs.

For DVDs encoded in DTS

Only 2 channel analog audio signals may be sent to the second room.

Use the disc menu to set the DVD player’s mixed 2-channel left and right audio outputs to the PCM or Dolby Digital soundtrack.

For CDs encoded in DTS

To avoid unexpected noise, DO NOT USE the Zone 2 feature with CDs encoded in DTS.

EDITING SOUND FIELD PARAMETERS

What is a sound field

What really creates the rich, full tones of a live instrument are the multiple reflections from the walls of the room. In addition to making the sound “live”, these reflections enable us to tell where the player is situated, and the size and shape of the room in which we are sitting.

■ Elements of a sound field

In any environment, in addition to the direct sound coming straight to our ears from the player’s instrument, there are two distinct types of sound reflections that combine to make up the sound field:

Early reflections

Reflected sounds reach our ears extremely rapidly (50 ms – 100 ms after the direct sound), after reflecting from one surface only – for example, from the ceiling or a wall. Early reflections actually add clarity to the direct sound.

Reverberations

These are caused by reflections from more than one surface – walls, ceiling, the back of the room – so numerous that they merge together to form a continuous sonic “afterglow”. They are non-directional, and lessen the clarity of the direct sound.

Direct sound, early reflections and subsequent reverberation taken together help us to determine the subjective size and shape of the room, and it is this information that the digital sound field processor reproduces in order to create sound fields.

If you could create the appropriate early reflections and subsequent reverberations in your listening room, you would be able to create your own listening environment. The acoustics in your room could be changed to those of a concert hall, a dance floor, or virtually any size room at all. This ability to create sound fields at will is exactly what YAMAHA has done with the digital sound field processor.

Changing parameter settings

You can enjoy good quality sound with the factory preset parameters. Although you do not have to change the initial settings, you can change some of the parameters to better suit the input source or your listening room.

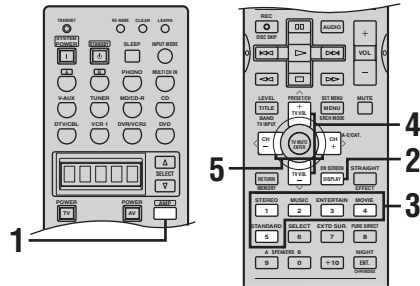

1 Press AMP.



2 Turn on the video monitor and press ON SCREEN repeatedly to select the full display mode.



3 Select the sound field program you want to adjust.

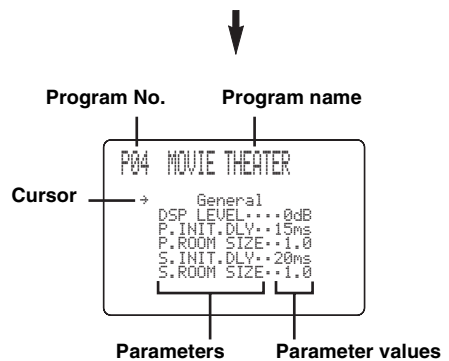
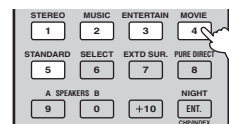

4 Press \wedge / \vee to select the parameters.

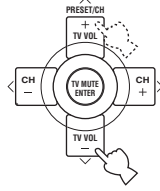

Resetting parameters to the factory presets

To reset all parameters

Use PARAM. INI (see page 72).

5 Press \langle / \rangle to change the parameter value.

When you set a parameter to a value other than the factory-set value, an asterisk mark (*) appears by the parameter name on the on-screen display.

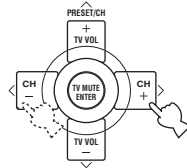

If you press and hold \langle / \rangle to change the parameter value, the front panel display automatically stops at the factory preset parameter momentarily.

6 Repeat steps 3 through 5 as necessary to change other program parameters.

Note

You cannot change parameter values when "MEMORY GUARD" is set to ON. If you want to change the parameter values, set "MEMORY GUARD" to OFF (see page 71).

Memory back-up

The memory back-up circuit prevents the stored data from being lost even if this unit is set in the standby mode, the power cord is disconnected from the AC outlet, or the power supply is temporarily cut due to power failure. However, if the power is cut for more than one week, the parameter values will return to the factory settings. If this happens, edit the parameter value again.

SOUND FIELD PARAMETER DESCRIPTIONS

You can adjust the values of certain digital sound field parameters so the sound fields are recreated accurately in your listening room. Not all of the following parameters are found in every program.

■ DSP LEVEL (DSP level)

Function: Adjusts the level of all the DSP effect sounds within a narrow range.

Description: Depending on the acoustics of your listening room, you may want to increase or decrease the DSP effect level relative to the level of the direct sound.

Control range: -6 dB to +3 dB

■ INIT. DLY/P. INIT. DLY (Initial delay)

Function: Changes the apparent distance from the source sound by adjusting the delay between the direct sound and the first reflection heard by the listener.

Description: The smaller the value, the closer the sound source seems to the listener. The larger the value, the farther it seems. For a small room, set to a small value. For a large room, set to a large value.

Control range: 1 to 99 msec

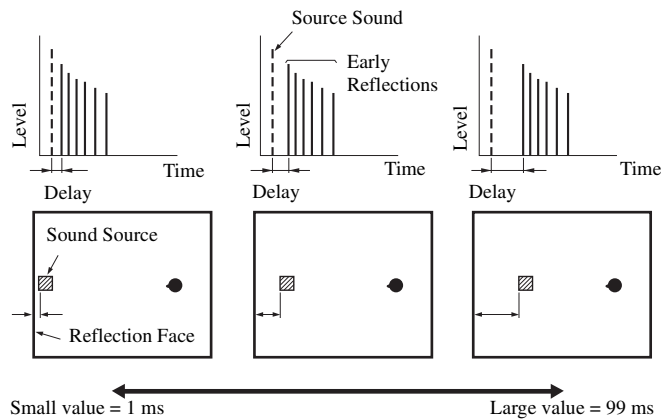

■ ROOM SIZE/P. ROOM SIZE (Room size)

Function: Adjusts the apparent size of the surround sound field. The larger the value, the larger the surround sound field becomes.

Description: As the sound is repeatedly reflected around a room, the larger the hall is, the longer the time between the original reflected sound and the subsequent reflections. By controlling the time between the reflected sounds, you can change the apparent size of the virtual venue. Changing this parameter from one to two, doubles the apparent length of the room.

Control range: 0.1 to 2.0

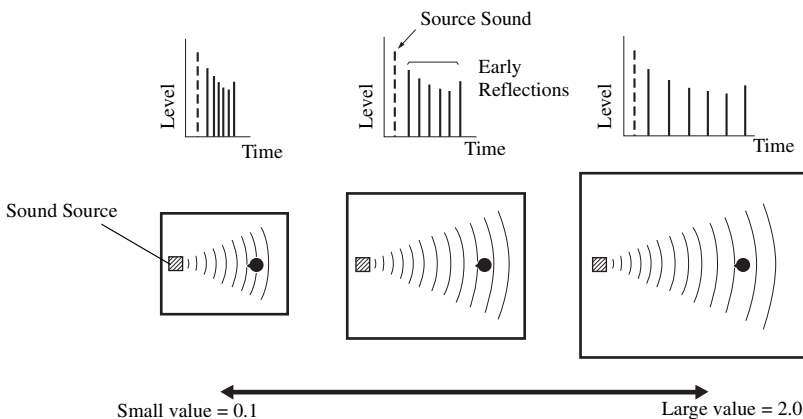

■ LIVENESS (Liveness)

Function: Adjusts the reflectivity of the virtual walls in the hall by changing the rate at which the early reflections decay.

Description: The early reflections of a sound source decay much faster in a room with acoustically absorbent wall surfaces than in one which has highly reflective surfaces. A room with acoustically absorbent surfaces is referred to as “dead”, while a room with highly reflective surfaces is referred to as “live”. The LIVENESS parameter lets you adjust the early reflection decay rate, and thus the “liveness” of the room.

Control range: 0 to 10

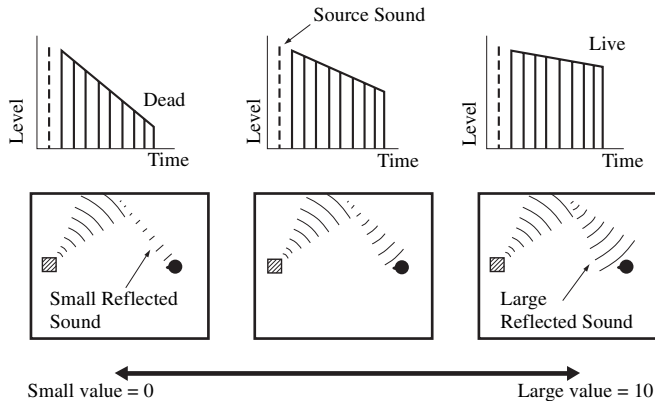

■ S. INIT. DLY (Surround initial delay)

Function: Adjusts the delay between the direct sound and the first reflection on the surround side of the sound field. You can only adjust this parameter when at least two front channels and two surround channels are used.

Control Range: 1 to 49 msec

■ S. ROOM SIZE (Surround room size)

Function: Adjusts the apparent size of the surround sound field.

Control Range: 0.1 to 2.0

■ S. LIVENESS (Surround liveness)

Function: Adjusts the apparent reflectivity of the virtual walls in the surround sound field.

Control Range: 0 to 10

■ SB INI. DLY (Surround back initial delay)

Function: Adjusts the delay between the direct sound and the first reflection in the surround back sound field.

Control Range: 1 to 49 msec

■ SB ROOM SIZE (Surround back room size)

Function: Adjusts the apparent size of the surround back sound field.

Control Range: 0.1 to 2.0

■ SB LIVENESS (Surround back liveness)

Function: Adjusts the apparent reflectivity of the virtual wall in the surround back sound field.

Control Range: 0 to 10

REV.TIME (Reverberation time)

Function: Adjusts the amount of time it takes for the dense, subsequent reverberation sound to decay by 60 dB (at 1 kHz). This changes the apparent size of the acoustic environment over an extremely wide range.

Description: Set a longer reverberation time for “dead” sources and listening room environments, and a shorter time for “live” sources and listening room environments.

Control Range: 1.0 to 5.0 sec

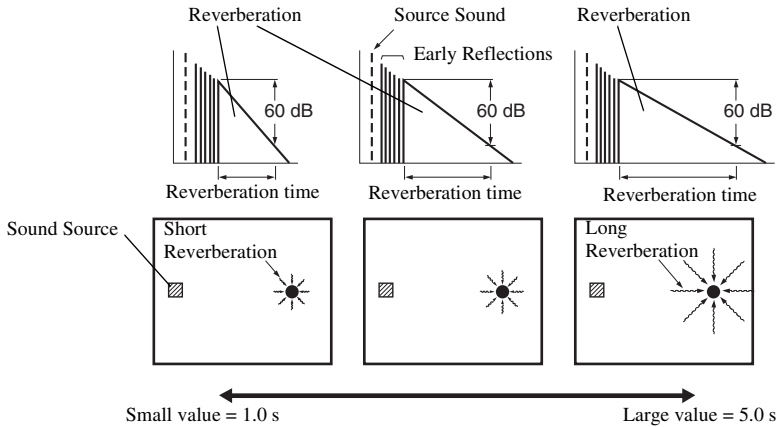

REV.DELAY (Reverberation delay)

Function: Adjusts the time difference between the beginning of the direct sound and the beginning of the reverberation sound.

Description: The larger the value, the later the reverberation sound begins. A later reverberation sound makes you feel like you are in a larger acoustic environment.

Control Range: 0 to 250 msec

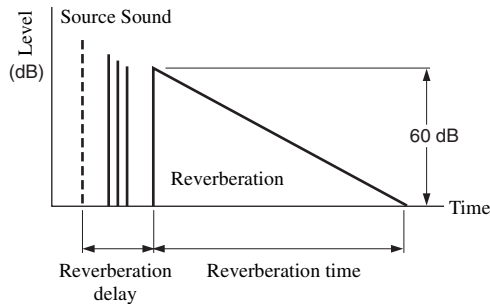

REV. LEVEL (Reverberation level)

Function: Adjusts the volume of the reverberation sound.

Description: The larger the value, the stronger the reverberation becomes.

Control Range: 0 to 100%

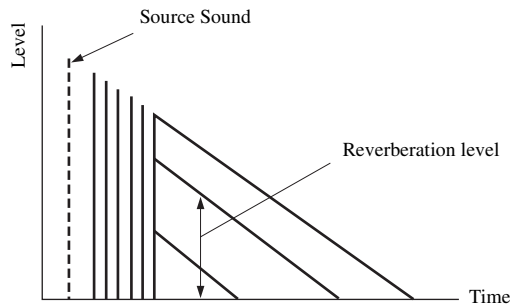

■ DIALG.LIFT (Dialog lift)

Function: Adjusts the height of the front and center channel sounds by assigning some of the front and center channel elements to the presence speakers.

Description: The larger the parameter, the higher the position of the front and center channel sound.

Choices: 0/1/2/3/4/5, initial setting is 0.

For 2ch Stereo:

■ DIRECT (Direct)

Function: Bypasses this unit's decoders and DSP processors for pure high fidelity sound when playing 2-channel analog sources.

Choices: **AUTO**, OFF

Notes

- When multi-channel signals (Dolby Digital and DTS) are input, they are downmixed to 2 channels and output from the front left and right speakers.
- When "BASS OUT" is set to BOTH, or "FRONT SP" set to SMALL and "BASS OUT" set to SWFR, front left and right speaker low-frequency signals are redirected to the subwoofer.

For 7ch Stereo:

Function: These parameters adjust the volume level for each channel in 7-channel stereo mode.

Control Range: 0 – 100%

■ CT LEVEL (Center level)

■ SL LEVEL (Surround left level)

■ SR LEVEL (Surround right level)

■ SB LEVEL (Surround back level)

■ PL LEVEL (Presence left level)

■ PR LEVEL (Presence level)

For PRO LOGIC IIx Music and PRO LOGIC II Music:

■ PANORAMA (Panorama)

Function: Sends stereo signals to the surround speakers as well as the front speakers for a wraparound effect.

Choices: **OFF**, ON

■ DIMENSION (Dimension)

Function: Gradually adjusts the sound field either towards the front or towards the rear.

Control range: -3 (towards the rear) to +3 (towards the front), initial setting is STD (standard).

■ CENTER WIDTH (Center width)

Function: Adjusts the center image from all three front speakers to varying degrees. A larger value adjusts the center image towards the front left and right speakers.

Control range: 0 (center channel sound is output only from center speaker) to 7 (center channel sound is output only from front left and right speakers)

Initial setting: 3

Note

This parameter can be set only when SUR.STANDARD is selected.

For DTS Neo:6 Music:

■ **C. IMAGE (Center image)**

Function: Adjusts the center image from all three front speakers to varying degrees.

Control range: 0 to 1.0

Initial setting: 0.3

Note

This parameter can be set only when SUR.STANDARD is selected.

TROUBLESHOOTING

Refer to the chart below when this unit does not function properly. If the problem you are experiencing is not listed below or if the instruction below does not help, set this unit to the standby mode, disconnect the power cord, and contact the nearest authorized YAMAHA dealer or service center.

■ General

Problem	Cause	Remedy	Refer to page
This unit fails to turn on when STANDBY/ON (or SYSTEM POWER) is pressed, or enters the standby mode soon after the power has been turned on.	The power cord is not connected or the plug is not completely inserted.	Connect the power cord firmly.	—
	The impedance setting is incorrect.	Set the impedance to match your speakers.	74
	The protection circuitry has been activated.	Make sure all speaker wire connections on this unit and on all speakers are secure and that the wire for each connection does not touch anything other than its respective connection.	11-14
	This unit has been exposed to a strong external electric shock (such as lightning or strong static electricity).	Set this unit in the standby mode, disconnect the power cord, plug it back in after 30 seconds, then use it normally.	—
On-screen display does not appear.	The setting for the on-screen display is set to “DISPLAY OFF”.	Select the full display or short display mode.	59
	“GRAY BACK” in SET MENU is set to OFF, and no video signal is currently being received.	Set “GRAY BACK” to AUTO to always show the OSD.	71
No sound	Incorrect input or output cable connections.	Connect the cables properly. If the problem persists, the cables may be defective.	15-20
	The optimizer microphone is connected.	Disconnect the optimizer microphone.	24
	The input mode is set to DTS or ANALOG.	Select AUTO.	37
	No appropriate input source has been selected.	Select an appropriate input source with INPUT, MULTI CH INPUT (or MULTI CH IN on the remote control) or the input selector buttons.	30
	Speaker connections are not secure.	Secure the connections.	12
	The front speakers to be used have not been selected properly.	Select the front speakers with SPEAKERS A and/or B.	30
	The volume is turned down.	Turn up the volume.	—
	The sound is muted.	Press MUTE or any operation button of this unit to resume audio output, then adjust the volume.	31
	The input mode is set to ANALOG while playing a source encoded with a DTS signal.	Set the input mode to AUTO or DTS.	37
	Signals this unit cannot reproduce are being received from a source component, such as a CD-ROM.	Play a source whose signals can be reproduced by this unit.	—
No picture	The output and input for the picture are connected to different types of video jacks.	Turn on the video conversion function.	71

Problem	Cause	Remedy	Refer to page
The sound suddenly goes off.	The protection circuitry has been activated because of a short circuit, etc.	Check that the impedance selector setting is correct.	74
		Check that the speaker wires are not touching each other and then turn this unit back on.	—
	The sleep timer has turned the unit off.	Turn on the power, and play the source again.	—
	The sound is muted.	Press MUTE to cancel a mute.	31
Only the speaker on one side can be heard.	Incorrect cable connections.	Connect the cables properly. If the problem persists, the cables may be defective.	12
	Incorrect balance settings in SET MENU.	Adjust the SPEAKER LEVEL settings.	66
Only the center speaker outputs substantial sound.	When playing a monaural source with a CINEMA DSP program, the source signal is directed to the center channel, and the front and surround speakers output effect sounds.		
No sound from the effect speakers.	The sound field programs are turned off.	Press STRAIGHT (EFFECT) to turn them on.	36
	You are using a source or program combination that does not output sound from all channels.	Try another sound field program.	56
No sound from the center speaker.	The output level of the center speaker is set to minimum.	Raise the level of the center speaker.	66
	“CENTER SP” in SET MENU is set to NONE.	Select the appropriate setting for the center speaker.	64
	One of the HiFi DSP programs (except for 7ch Stereo) has been selected.	Try another sound field program.	56
No sound from the surround speakers.	The output level of the surround speakers is set to minimum.	Raise the output level of the surround speakers.	66
	“SUR. L/R SP” in SET MENU is set to NONE.	Select the appropriate setting for the surround left and right speakers.	64
	A monaural source is being played with STRAIGHT.	Press STRAIGHT (EFFECT) to turn on the sound fields.	—
No sound from the surround back speakers.	Presence speakers are selected.	Select surround back speakers in SUR. B L/R SP.	65
	“SUR. L/R SP” in SET MENU is set to NONE.	If the surround left and right speakers are set to NONE, the surround back speaker setting is automatically set to NONE. Select the appropriate setting for the surround speakers.	64
	“SUR. B L/R SP” in SET MENU is set to NONE.	Select LRGx1 or SMLx1.	65
No sound from the subwoofer.	“LFE/BASS OUT” in SET MENU is set to FRNT when a Dolby Digital or DTS signal is being played.	Select SWFR or BOTH.	65
	“LFE/BASS OUT” in SET MENU is set to SWFR or FRNT when a 2-channel source is being played.	Select BOTH.	65
	The source does not contain low bass signals.		

Problem	Cause	Remedy	Refer to page
Dolby Digital or DTS sources cannot be played. (Dolby Digital or DTS indicator on the front panel display does not light up.)	The connected component is not set to output Dolby Digital or DTS digital signals.	Make an appropriate setting following the operating instructions for your component.	—
	The input mode is set to ANALOG.	Set the input mode to AUTO or DTS.	37
A “humming” sound can be heard.	Incorrect cable connections.	Firmly connect the audio plugs. If the problem persists, the cables may be defective.	—
	No connection from the turntable to the GND terminal.	Connect the grounding cord of your turntable to the GND terminal of this unit.	19
The volume level is low while playing a record.	The record is being played on a turntable with an MC cartridge.	The turntable should be connected to this unit through an MC-head amplifier.	19
The volume level cannot be increased, or the sound is distorted.	The component connected to the OUT (REC) jacks of this unit is turned off.	Turn on the power to the component.	—
The sound effect cannot be recorded.	It is not possible to record the sound effect with a recording component.		
A source cannot be recorded by a digital recording component connected to this DIGITAL OUTPUT jack.	The source component is not connected to this unit’s DIGITAL INPUT jacks.	Connect the source component to the DIGITAL INPUT jacks.	15-19
	Some components cannot record the Dolby Digital or DTS sources.		
A source cannot be recorded by an analog component connected to the AUDIO OUT jacks.	The source component is not connected to this unit’s analog AUDIO IN jacks.	Connect the source component to the analog AUDIO IN jacks.	15-19
The sound field parameters and some other settings on this unit cannot be changed.	“MEMORY GUARD” in SET MENU is set to ON.	Select OFF.	71
This unit does not operate properly.	The internal microcomputer has been frozen by an external electric shock (such as lightning or excessive static electricity) or by a power supply with low voltage.	Disconnect the AC power cord from the outlet and then plug it in again after about 30 seconds.	—
“CHECK SP WIRES” appears in the front panel display.	Speaker cables are short circuited.	Make sure all speaker cables are connected correctly.	12

Problem	Cause	Remedy	Refer to page
There is noise interference from digital or radio frequency equipment, or this unit.	This unit is too close to the digital or high-frequency equipment.	Move this unit further away from such equipment.	—
The picture is disturbed.	The video source uses scrambled or encoded signals to prevent dubbing.		
There is noise when the OSD is displayed.	The OSD may be disturbed when displaying OSD through component video connections.	Select OFF in CMPNT OSD.	71
This unit suddenly turns into the standby mode.	The internal temperature becomes too high and the overheat protection circuitry has been activated.	Wait about 1 hour for this unit to cool down and then turn it back on.	—

■ **Tuner**

Problem	Cause	Remedy	Refer to page	
FM	FM stereo reception is noisy.	The characteristics of FM stereo broadcasts may cause this problem when the transmitter is too far away or the antenna input is poor.	Check the antenna connections. Try using a high-quality directional FM antenna.	21
			Use the manual tuning method.	40
	There is distortion, and clear reception cannot be obtained even with a good FM antenna.	There is multipath interference.	Adjust the antenna position to eliminate multipath interference.	—
	The desired station cannot be tuned in with the automatic tuning method.	The signal is too weak.	Use a high-quality directional FM antenna.	21
			Use the manual tuning method.	40
	Previously preset stations can no longer be tuned in.	This unit has been disconnected for a long period.	Preset the stations again.	40
AM	The desired station cannot be tuned in with the automatic tuning method.	The signal is weak or the antenna connections are loose.	Tighten the AM loop antenna connections and orient it for the best reception.	—
			Use the manual tuning method.	40
	There are continuous crackling and hissing noises.	Noises result from lightning, fluorescent lamps, motors, thermostats and other electrical equipment.	Use an outdoor antenna and a ground wire. This will help somewhat, but it is difficult to eliminate all noise.	—
	There are buzzing and whining noises.	A TV set is being used nearby.	Move this unit away from the TV.	—

■ Remote control

Problem	Cause	Remedy	Refer to page
The remote control does not work nor function properly.	Wrong distance or angle.	The remote control will function within a maximum range of 6 m (20 ft) and no more than 30 degrees off-axis from the front panel.	7
	Direct sunlight or lighting (from an inverter type of fluorescent lamp, etc.) is striking the remote control sensor of this unit.	Reposition this unit.	—
	The batteries are weak.	Replace all batteries.	3
	The manufacturer code was not correctly set.	Set the remote control code correctly.	76
		Try setting another code for the same manufacturer.	76
	The remote control ID and this unit's ID do not match.	Switch the library code.	74, 76
Even if the remote control code is correctly set, there are some models that do not respond to the remote control.	Program the necessary functions independently into the programmable buttons using the Learn feature.	79	
The remote control does not "learn" new functions.	The batteries of this remote control and/or the other remote control are too weak.	Replace the batteries.	3
	The distance between the two remote controls is too much or too little.	Place the remote controls at the proper distance.	79
	The signal coding or modulation of the other remote control is not compatible with this remote control.	Learning is not possible.	—
	Memory capacity is full.	Delete other unnecessary functions to make room for the new functions.	82

RESETTING THE FACTORY PRESETS

If you want to reset all of your unit's parameters for any reason, do the following. This procedure completely resets ALL parameters, including the SET MENU, level, assign and tuner presets.

Be sure this unit is in standby mode.

(U.S.A. model)

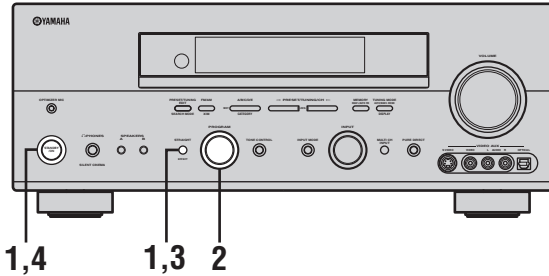

- 4 Press STANDBY/ON to confirm your selection.**



If you selected "RESET", the unit is reset to its factory presets and switches to standby mode. If you selected "CANCEL", the unit switches to standby mode and nothing is reset.

- 1 With the unit in the standby mode, hold down STRAIGHT (EFFECT) on the front panel and press STANDBY/ON.**

The ADVANCED SETUP menu appears in the front panel display.



While holding down, press



To cancel the initialization procedure without making any changes, press STANDBY/ON.

- 2 Rotate PROGRAM to move through the menu and select "PRESET".**



- 3 Press STRAIGHT (EFFECT) to select the desired setting.**



RESET To reset the unit to its factory presets.
CANCEL To cancel without making any changes.

GLOSSARY

Audio formats

■ Dolby Digital

Dolby Digital is a digital surround sound system that gives you completely independent multi-channel audio. With 3 front channels (left, center, and right), and 2 surround stereo channels, Dolby Digital provides 5 full-range audio channels. With an additional channel especially for bass effects, called LFE (low frequency effect), the system has a total of 5.1-channels (LFE is counted as 0.1 channel). By using 2-channel stereo for the surround speakers, more accurate moving sound effects and surround sound environment are possible than with Dolby Surround. The wide dynamic range (from maximum to minimum volume) reproduced by the 5 full-range channels and the precise sound orientation generated using digital sound processing provide listeners with previously unheard of excitement and realism.

With this unit, any sound environment from monaural up to a 5.1-channel configuration can be freely selected for your enjoyment.

■ Dolby Digital EX

Dolby Digital EX creates 6 full-bandwidth output channels from 5.1-channel sources. This is done using a matrix decoder that derives 3 surround channels from the 2 in the original recording. For the best results, Dolby Digital EX should be used with movie sound tracks recorded with Dolby Digital Surround EX. With this additional channel, you can experience more dynamic and realistic moving sound especially with scenes with “flyover” and “fly-around” effects.

■ Dolby Pro Logic II

Dolby Pro Logic II is an improved technique used to decode vast numbers of existing Dolby Surround software. This new technology enables a discrete 5-channel playback with 2 front left and right channels, 1 center channel, and 2 surround left and right channels (instead of only 1 surround channel for conventional Pro Logic technology). Music and Game modes are also available for 2-channel sources in addition to the Movie mode.

■ Dolby Pro Logic IIx

Dolby Pro Logic IIx is a new technology enabling discrete multi-channel playback from 2-channel or multi-channel sources. There is a Music mode for music, a Movie mode for movies and a Game mode for games.

■ Dolby Surround

Dolby Surround uses a 4 channel analog recording system to reproduce realistic and dynamic sound effects: 2 front left and right channels (stereo), a center channel for dialog (monaural), and a surround channel for special sound effects (monaural). The surround channel reproduces sound within a narrow frequency range.

Dolby Surround is widely used with nearly all video tapes and laser discs, and in many TV and cable broadcasts as well. The Dolby Pro Logic decoder built into this unit employs a digital signal processing system that automatically stabilizes the volume on each channel to enhance moving sound effects and directionality.

■ DTS 96/24

DTS 96/24 offers an unprecedented level of audio quality for multi-channel sound on DVD-Video, and is fully backward-compatible with all DTS decoders. “96” refers to a 96 kHz sampling rate (compared to the typical 48 kHz sampling rate). “24” refers to 24-bit word length. DTS 96/24 offers sound quality transparent to the original 96/24 master, and 96/24 5.1-channel sound with full-quality full-motion video for music programs and motion picture soundtracks on DVD-video.

■ DTS (Digital Theater Systems) Digital Surround

DTS digital surround was developed to replace the analog soundtracks of movies with a 6-channel digital sound track, and is now rapidly gaining popularity in movie theaters around the world. Digital Theater Systems Inc. has developed a home theater system so that you can enjoy the depth of sound and natural spatial representation of DTS digital surround in your home. This system produces practically distortion-free 6-channel sound (technically, a left, right and center channels, 2 surround channels, plus an LFE 0.1 channel as a subwoofer, for a total of 5.1-channels). The unit incorporates DTS-ES decoder that enables 6.1-channel reproduction by adding the surround back channel to existing 5.1-channel format.

■ Neo:6

Neo:6 decodes the conventional 2-channel sources for 6 channel playback by the specific decoder. It enables playback with the full-range channels with higher separation just like digital discrete signal playback. Two modes are available; “Music mode” for playing music sources and “Cinema mode” for movies.

Sound field programs

■ CINEMA DSP

Since the Dolby Surround and DTS systems were originally designed for use in movie theaters, their effect is best felt in a theater having many speakers and designed for acoustic effects. Since home conditions, such as room size, wall material, number of speakers, and so on, can differ so widely, it's inevitable that there are differences in the sound heard as well. Based on a wealth of actually measured data, YAMAHA CINEMA DSP uses YAMAHA original sound field technology to combine Dolby Pro Logic, Dolby Digital and DTS systems to provide the visual and audio experience of movie theater in the listening room of your own home.

■ SILENT CINEMA

YAMAHA has developed a natural, realistic sound effect DSP algorithm for headphones. Parameters for headphones have been set for each sound field so that accurate representations of all the sound field programs can be enjoyed on headphones.

■ Virtual CINEMA DSP

YAMAHA has developed a Virtual CINEMA DSP algorithm that allows you to enjoy DSP sound field surround effects even without any surround speakers by using virtual surround speakers. It is even possible to enjoy Virtual CINEMA DSP using a minimal two-speaker system that does not include a center speaker.

Audio information

■ ITU-R

ITU-R is the radio communication sector of the ITU (International Telecommunication Union). ITU-R recommends a standard speaker placement which is used in many critical listening rooms, especially for mastering purposes.

■ LFE 0.1 channel

This channel is for the reproduction of low bass signals. The frequency range for this channel is 20 Hz to 120 Hz. This channel is counted as 0.1 because it only enforces a low frequency range compared to the full-range reproduced by the other 5/6 channels in Dolby Digital or DTS 5.1/6.1-channel systems.

■ PCM (Linear PCM)

Linear PCM is a signal format under which an analog audio signal is digitized, recorded and transmitted without using any compression. This is used as a method of recording CDs and DVD audio. The PCM system uses a technique for sampling the size of the analog signal per very small unit of time. Standing for "pulse code modulation", the analog signal is encoded as pulses and then modulated for recording.

■ Sampling frequency and number of quantized bits

When digitizing an analog audio signal, the number of times the signal is sampled per second is called the sampling frequency, while the degree of fineness when converting the sound level into a numeric value is called the number of quantized bits.

The range of rates that can be played back is determined based on the sampling rate, while the dynamic range representing the sound level difference is determined by the number of quantized bits. In principle, the higher the sampling frequency, the wider the range of frequencies that can be played back, and the higher the number of quantized bits, the more finely the sound level can be reproduced.

Video signal information

■ **Component video signal**

With the component video signal system, the video signal is separated into the Y signal for the luminance and the Pb and Pr signals for the chrominance. Color can be reproduced more faithfully with this system because each of these signals is independent. The component signal is also called the “color difference signal” because the luminance signal is subtracted from the color signal.

A monitor with component input jacks is required in order to use the component signal for output.

■ **Composite video signal**

With the composite video signal system, the video signal is composed of three basic elements of a video picture; color, brightness and synchronization data. A composite video jack on a video component transmits these three elements combined.

■ **S-video signal**

With the S-video signal system, the video signal normally transmitted using a pin cable is separated and transmitted as the Y signal for the luminance and the C signal for the chrominance through the S-video cable. Using the S VIDEO jack eliminates video signal transmission loss and allows recording and playback of even more beautiful images.

SPECIFICATIONS

AUDIO SECTION

- Minimum RMS Output Power for Front, Center, Surround, Surround back
20 Hz to 20 kHz, 0.06% THD, 8 Ω 100 W
- Maximum Power (EIAJ)
[China, Korea and General models]
1 kHz, 10% THD, 8 Ω 140 W
- Dynamic Power (IHF)
8/6/4/2 Ω 135/170/200/245 W
- DIN Standard Output Power [U.K. and Europe models]
1 kHz, 0.7% THD, 4 Ω 150 W
- IEC Output Power [U.K. and Europe models]
1 kHz, 0.06% THD, 8 Ω 110 W
- Damping Factor (IHF)
20 Hz to 20 kHz, 8 Ω 120 or more
- Frequency Response
CD terminal to Front L/R 10 Hz to 100 kHz, -3 dB
- Total Harmonic Distortion
PHONO to REC OUT (20 Hz to 20 kHz, 1 V) 0.02% or less
CD, etc. to Front L/R
(20 Hz to 20 kHz, 50 W, 8 Ω) 0.06% or less
- Signal to Noise Ratio (IHF-A Network)
Phono (5 mV) to REC OUT
[U.K., Europe and Australia models] 81 dB or more
[Other models] 86 dB or more
CD (250 mV) to Front L/R, Effect Off 100 dB or more
- Residual Noise (IHF-A Network)
Front L/R 150 μV or less
- Channel Separation (1 kHz/10 kHz)
PHONO (shorted) to Front L/R 60 dB/55 dB or more
CD (5.1 kΩ terminated) to Front L/R 60 dB/45 dB or more
- Tone Control (Front L/R)
BASS Boost/Cut ±6 dB/50 Hz
BASS Turnover Frequency 350 Hz
TREBLE Boost/Cut ±6 dB/20 kHz
TREBLE Turnover Frequency 3.5 kHz
- Phones Output 150 mV/100 Ω
- Input Sensitivity/Input Impedance
PHONO 2.5 mV/47 kΩ
CD, etc. 200 mV/47 kΩ
MULTI CH INPUT 200 mV/47 kΩ
- Output Level/Output Impedance
REC OUT 200 mV/1.2 kΩ
PRE OUT 2 V/1.2 kΩ
SUB WOOFER 4 V/1.7 kΩ
ZONE 2 OUTPUT
[U.S.A., Canada, Australia and
Europe models] 200 mV/1.2 kΩ

VIDEO SECTION

- Video Signal Type PAL/NTSC
- Signal to Noise Ratio 50 dB or more
- Frequency Response (MONITOR OUT)
Composite, S-video 5 Hz to 10 MHz, -3 dB
Component 5 Hz to 60 MHz, -3 dB

FM SECTION*

- Tuning Range
[U.S.A. and Canada models] 87.5 to 107.9 MHz
[General model] 87.5/87.50 to 108.0/108.00 MHz
[Other models] 87.50 to 108.00 MHz
- Usable Sensitivity (IHF) 1.0 μV (11.2 dBf)
- Signal to Noise Ratio (IHF)
Mono/Stereo 76 dB/70 dB
- Harmonic Distortion (1 kHz)
Mono/Stereo 0.2%/0.3%
- Stereo Separation (1 kHz) 42 dB
- Frequency Response 20 Hz to 15 kHz, +0.5, -2 dB

AM SECTION*

- Tuning Range
[U.S.A. and Canada models] 530 to 1710 kHz
[General model] 530/531 to 1710/1611 kHz
[Other models] 531 to 1611 kHz
- Usable Sensitivity 300 μV/m

GENERAL

- Power Supply
[U.S.A. and Canada models] AC 120 V, 60 Hz
[Australia model] AC 240 V, 50 Hz
[China model] AC 220 V, 50 Hz
[Korea model] AC 220 V, 60 Hz
[U.K. and Europe models] AC 230 V, 50 Hz
[General model] AC 110/120/220/230-240 V, 50/60 Hz
- Power Consumption
[U.S.A. and Canada models] 400 W/500 VA
[Other models] 440 W
- Standby Power Consumption 0.1 W or less
- AC Outlets
[U.K. and Australia models] 1 (Total 100 W maximum)
[U.S.A., Canada and China models]... 2 (Total 100 W maximum)
[Europe and General models] 2 (Total 50 W maximum)
- Dimensions (W x H x D) 435 x 171 x 420 mm
(17-1/8" x 6-3/4" x 16-1/2")
- Weight 12.5 kg (27 lbs 9 oz)

*Except Europe model



© 2005 YAMAHA CORPORATION All rights reserved.

YAMAHA ELECTRONICS CORPORATION, USA 6660 ORANGETHORPE AVE., BUENA PARK, CALIF. 90620, U.S.A.
YAMAHA CANADA MUSIC LTD. 135 MILNER AVE., SCARBOROUGH, ONTARIO M1S 3R1, CANADA
YAMAHA ELECTRONIK EUROPA G.m.b.H. SIEMENSSTR. 22-34, 25462 RELLINGEN BEI HAMBURG, GERMANY
YAMAHA ELECTRONIQUE FRANCE S.A. RUE AMBROISE CROIZAT BP70 CROISSY-BEAUBOURG 77312 MARNE-LA-VALLEE CEDEX02, FRANCE
YAMAHA ELECTRONICS (UK) LTD. YAMAHA HOUSE, 200 RICKMANSWORTH ROAD WATFORD, HERTS WD18 7GQ, ENGLAND
YAMAHA SCANDINAVIA A.B. J A WETTERGRENS GATA 1, BOX 30053, 400 43 VÄSTRA FRÖLUNDA, SWEDEN
YAMAHA MUSIC AUSTRALIA PTY, LTD. 17-33 MARKET ST., SOUTH MELBOURNE, 3205 VIC., AUSTRALIA

YAMAHA CORPORATION
Printed in Malaysia ◀ WE59930